



**The Bahamas
Maritime Authority**

THE COMMONWEALTH OF THE BAHAMAS

**M.v. Baltic Ace
IMO Number 9386213
Official Number 8001370**



**Report of the investigation into the loss of m.v Baltic
Ace following a collision with m.v Corvus J at the
North Hinder Junction Precautionary Area on the 5th
December 2012**

The Bahamas conducts marine safety or other investigations on ships flying the flag of the Commonwealth of the Bahamas in accordance with the obligations set forth in International Conventions to which The Bahamas is a Party. In accordance with the IMO Casualty Investigation Code, mandated by the International Convention for the Safety of Life at Sea (SOLAS) Regulation XI-1/6, investigations have the objective of preventing marine casualties and marine incidents in the future and do not seek to apportion blame or determine liability.

It should be noted that the Bahamas Merchant Shipping Act, Para 170 (2) requires officers of a ship involved in an accident to answer an Inspector's questions fully and truly. If the contents of a report were subsequently submitted as evidence in court proceedings relating to an accident this could offend the principle that a person cannot be required to give evidence against himself. The Bahamas Maritime Authority makes this report available to any interested parties on the strict understanding that it will not be used as evidence in any court proceedings anywhere in the world.

Date of Issue: 27th May 2016
Bahamas Maritime Authority
120 Old Broad Street
LONDON
EC2N 1AR
United Kingdom

CONTENTS

1. Summary
2. Particulars of Vessel
 - 2.1 Details of Vessels
 - 2.1.1 Baltic Ace
 - 2.1.3 Corvus J
 - 2.2 Condition of Baltic Ace
 - 2.3 Crew Particulars
3. Narrative of events
 - 3.1 Time zone
 - 3.2 Baltic Ace – Departure from Zeebrugge
 - 3.3 Corvus J – Transit from Grangemouth to Antwerp
 - 3.4 Other Vessels in Vicinity
 - 3.5 Timeline of Events
 - 3.6 Collision and Separation
 - 3.7 Search and Rescue Operation
 - 3.8 Evacuation from Baltic Ace
4. Analysis
 - 4.1 Aim
 - 4.2 General Observations
 - 4.3 Manning
 - 4.4 Weather Conditions
 - 4.5 Action to Avoid a Collision
 - 4.6 Damage Assessment
 - 4.7 Abandonment
 - 4.8 Search and Rescue Effort
5. Conclusions
 - 5.1 Risk of Collision
 - 5.2 Safe Speed
 - 5.3 Sinking of the Baltic Ace
 - 5.4 Evacuation
6. Recommendations

m.v Baltic Ace – Marine Safety Investigation Report

List of Appendices:

- I. Baltic Ace General Arrangement Plan
- II. Baltic Ace Damage Plot
- III. Baltic Ace Salvage Pictures

Glossary

ARPA	Automatic Radar Plotting Aid
ATHARWTSHIP	A direction across the vessel, at right-angles to the fore and aft centreline
CAPSIZING	Loss of transverse stability, inclining moment exceeds righting moment resulting in the vessel rolling over
COLREGS	International Convention on Regulation for Preventing Collisions at Sea, 1972 (IRPCS)
CPA	Closest point of approach between two vessels
DNV	Det Norske Veritas
DSC	Digital Selective Calling (via GMDSS)
FSE	Free Surface Effect - Loss of GM due to the unobstructed atharwtskip movement of water
GL	Germanischer Lloyd
GM	Metacentric height
GMDSS	Global Maritime Distress & Safety System
GPS	Global Positioning System
HEEL	A “transient” inclination of a vessel caused by outside forces such as winds, waves, or during a vessel's turn
IMO	International Maritime Organisation
LIST	An inclined condition of vessel, caused by one of the following conditions: 1. Off-Centre Weight 2. Negative GM 3. Combination of Off-Centre Weight and GM
MAYDAY	An international recognised emergency procedure phrase used as a distress signal in voice procedure radio communications

m.v Baltic Ace – Marine Safety Investigation Report

NM	Nautical Mile (2027yds or 10 cables)
OOW	Officer of the Watch (Officer in charge of the navigational watch)
RCC	Rescue Coordination Centre
SMD	Safe Manning Document
SOLAS	International Convention for the Safety of Life at Sea 1974, as amended
STCW	International Convention on Standards of Training, Certification and Watchkeeping for Seafarers
STCW II/1	Mandatory minimum requirements from certification of Officers in charge of a navigational watch on vessels of 500 gross tonnage or more
STCW II/2	Mandatory minimum requirements from certification of masters and chief mates on vessels of 500 gross tonnage or more
TRIM	The longitudinal inclination of a vessel
VDR	Voyage Data Recorder
VHF	Very High Frequency communications (typically line of sight)

1 SUMMARY

- 1.1 At 1815 Universal Time Constant (UTC) on the 5th December 2012, the Bahamas registered vehicle carrier Baltic Ace collided with the Cyprus registered feeder container vessel Corvus J in position 51° 51.9'N 002° 53.9'E, located within the Noordhinder Junction area of the southern North Sea.
- 1.2 On the 1st December, Baltic Ace sailed from Kotka, Finland to Zeebrugge, Belgium in order to load 1,417 vehicles. On completion of loading on the day of the collision the vessel departed Zeebrugge bound for a return journey to Kotka, Finland.
- 1.3 At the time of the collision the two vessels were at the opposite ends of their respective sea passages. Corvus J sailed from Grangemouth, Scotland on the evening of the 4th December bound for Antwerp, Belgium and was enroute to the Steenbank pilot boarding station to receive a pilot for the passage thereafter into the Schelde River. The Baltic Ace disembarked the pilot at the Wandelaar pilot station shortly after departing Zeebrugge, Belgium at approximately 1615(UTC).
- 1.4 Both vessels were visually observed from one another at a range of approximately 8nm; however various aids to navigation provided a greater range of detection and were used to good effect in the initial stages of identifying and tracking the movements and relative bearings from one another.
- 1.5 The environmental conditions on the evening of the 5th December were not considered unusual for the southern North Sea in December; consisting of moderate visibility between 5nm and 8nm, sea state 5 (average wave height 4 - 5.5m) owing to a north westerly wind of between 28 and 33 knots (Beaufort Force 7, near gale).
- 1.6 From approximately 1800 (UTC) to the point of impact at 1815(UTC) both vessels were in the vicinity of the North Hinder Junction, a precautionary area where vessels are advised to proceed with caution as traffic flows merge due to the four traffic separation scheme (TSS) terminations in the vicinity.
- 1.7 The severity of the collision resulted in structural damage to both vessels, however damage sustained to the Baltic Ace resulted in catastrophic hull plating breach to the vehicle carrier's cargo compartment to such an extent the vessel sank within fifteen minutes after impact. Despite an immediate evacuation from the vessel being initiated, of the 24 crew on board only 13 were rescued, 8 recovered deceased and 3 remain missing, presumed deceased.

- 1.8 Despite an early detection of risk of collision, neither vessel took appropriate avoiding action in accordance with the International Regulations for Preventing Collisions at Sea 1972, as amended (COLREGS). The deviation from COLREGS, in addition to several other contributory factors, is considered to be the cause of this marine casualty resulting in the loss of 11 seafarers.

m.v Baltic Ace – Marine Safety Investigation Report

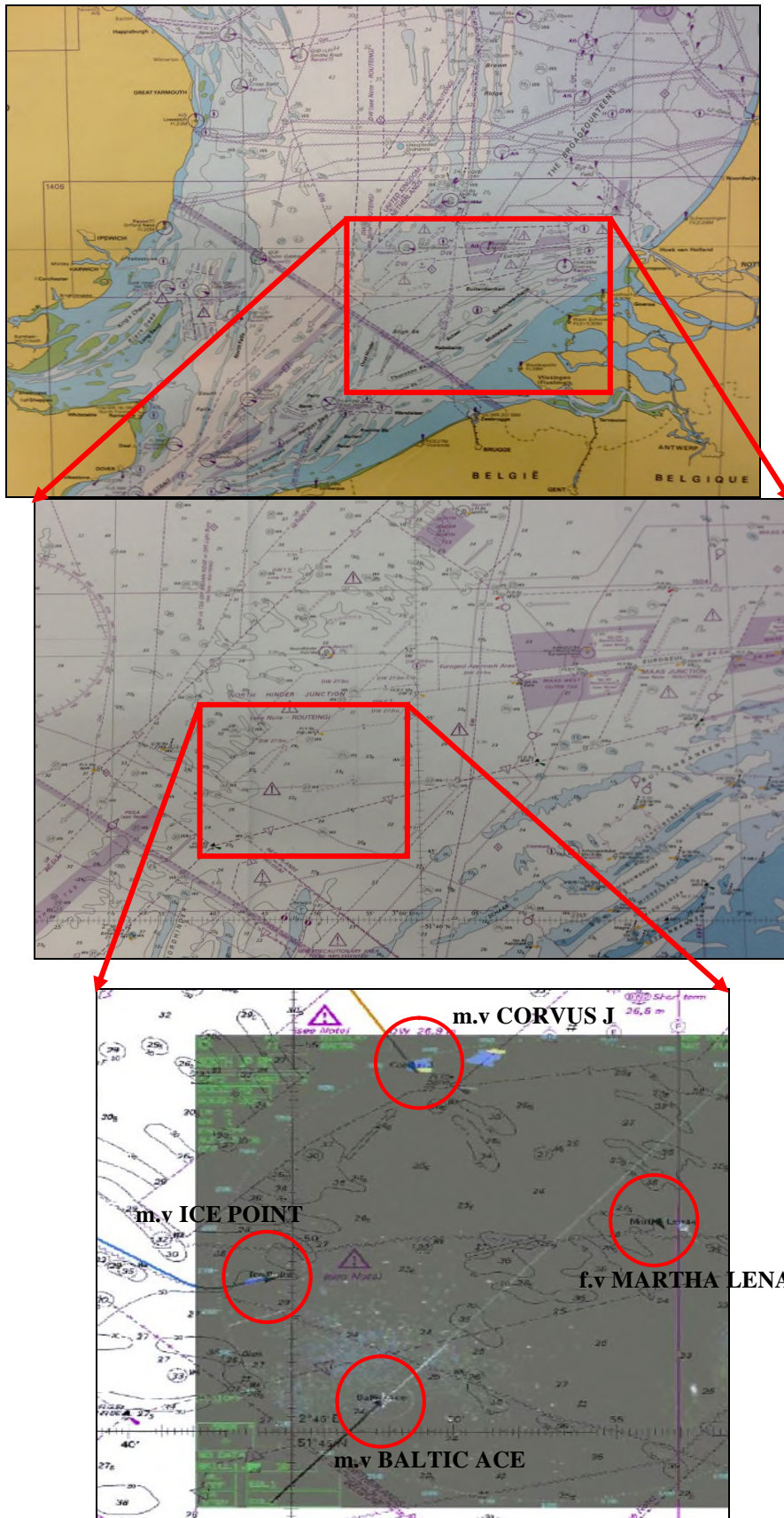

Figure 1: Expanding charts providing general overview of area and location of vessels at 1750(UTC)

2 PARTICULARS OF VESSEL

2.1.1 The Baltic Ace was a purpose built vehicle carrier of all steel construction registered in the port of Nassau, Bahamas.



Figure 2: Baltic Ace (Source: Open source)

2.1.2 The vessel was constructed in 2007 in the Gdynia Shipyard, Poland and at the time of the incident, was under classification with Det Norske Veritas (DNV). The vessel was owned by Baltic Highway Ltd and managed and operated by Stamco Ship Management. The following principal particulars were noted:

Official Number	8001370
IMO Number	9386213
Call Sign	C6WE8
Built	2007 – Stocznia Gdynia SA – Gdynia, Poland
Length Overall	147.93 m
Breadth	25.03 m
Draught	7.90 m
Depth to Deck 4 (entrance)	11.80 m
Depth to Deck 9 (at side)	25.20 m
Tonnage	23498 (Gross)
Tonnage	7050 (Net)
Class Entry	Car Carrier

m.v Baltic Ace – Marine Safety Investigation Report

Class Notation	DNV +1A1, MCDK, ICE-1A, EO, NAUT-OC, TMON, CLEAN
Propulsion	1 x MAN B&W 7s46MC-C
Brake Shaft Power	9170.00 kW
Service Speed	19.0 kts
Complement	25 (+ 4 Suez Crew)

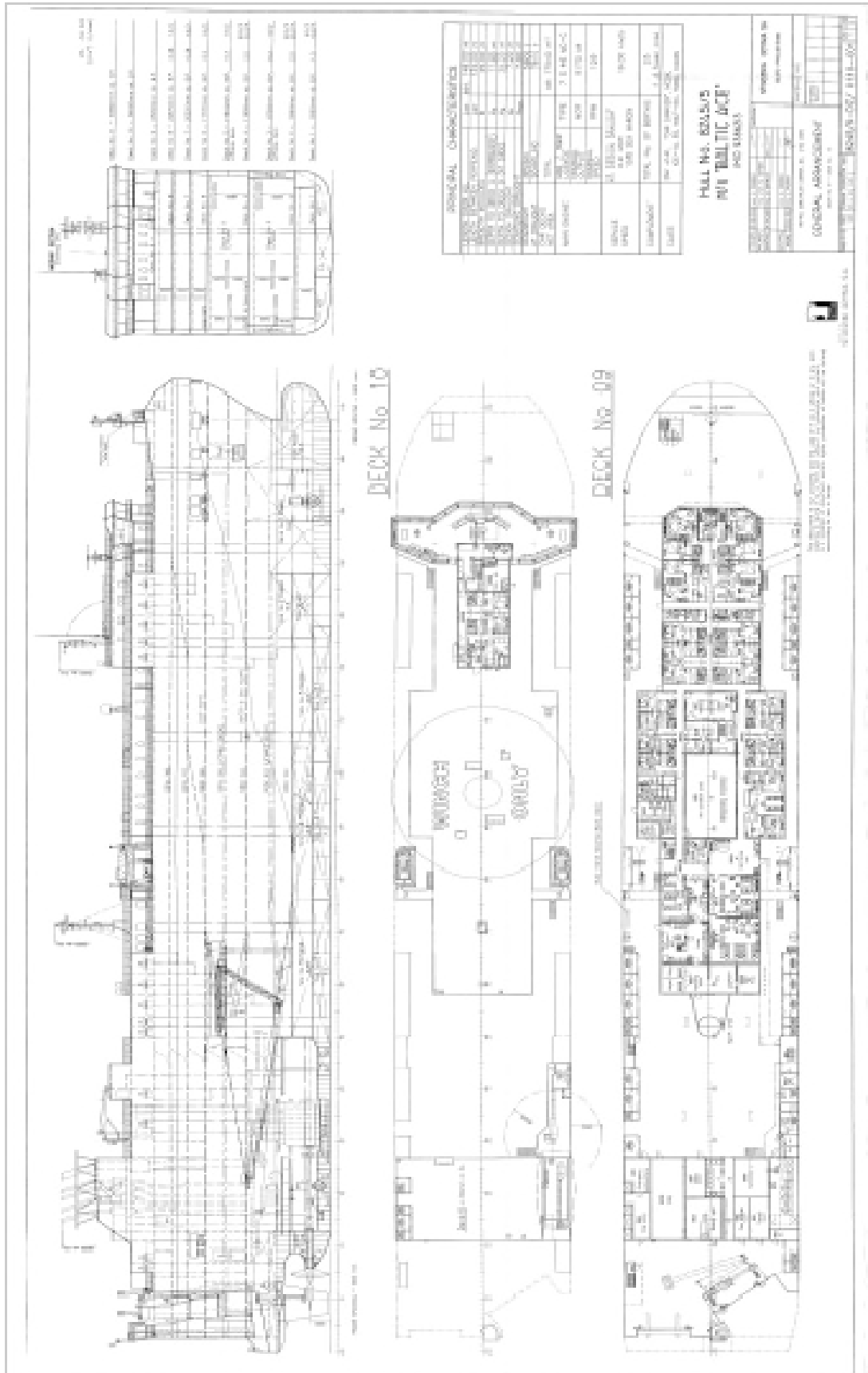

Figure 3: Baltic Ace general arrangement plan (GA plan of decks 1-8 located at appendix I)

- 2.1.3 The Corvus J is a full cellular container vessel of all steel construction registered in the port of Limassol, Cyprus.



Figure 4: Corvus J (Source: Open source)

- 2.1.4 The vessel was constructed in 2003 in the Hegemann Berne shipyard in Germany and at the time of the collision was under classification with Germanischer Lloyd (GL). The vessel was owned by Mare Corvus J and managed and operated by Jungerhans Maritime Services. The following principal particulars were noted:

Official Number	3961
IMO Number	9262895
Call Sign	5BRV3
Built	2003 – Detlef Hegemann Rolandwerft GmbH & Co. KG - Berne
Length Overall	134.06 m
Breadth	19.60 m
Draught	7.30 m
Depth (to main deck)	9.45 m
Tonnage	6370 (Gross)
Cargo Hold Capacity	10040 m ³
Class Entry	600 TEU Container Ship
Class Notation	GL 100 A5 E MC E AUT
Propulsion	MAK 8M 43
Brake Shaft Power	7300 kW

m.v Baltic Ace – Marine Safety Investigation Report

Service Speed	18 kts
Complement	16

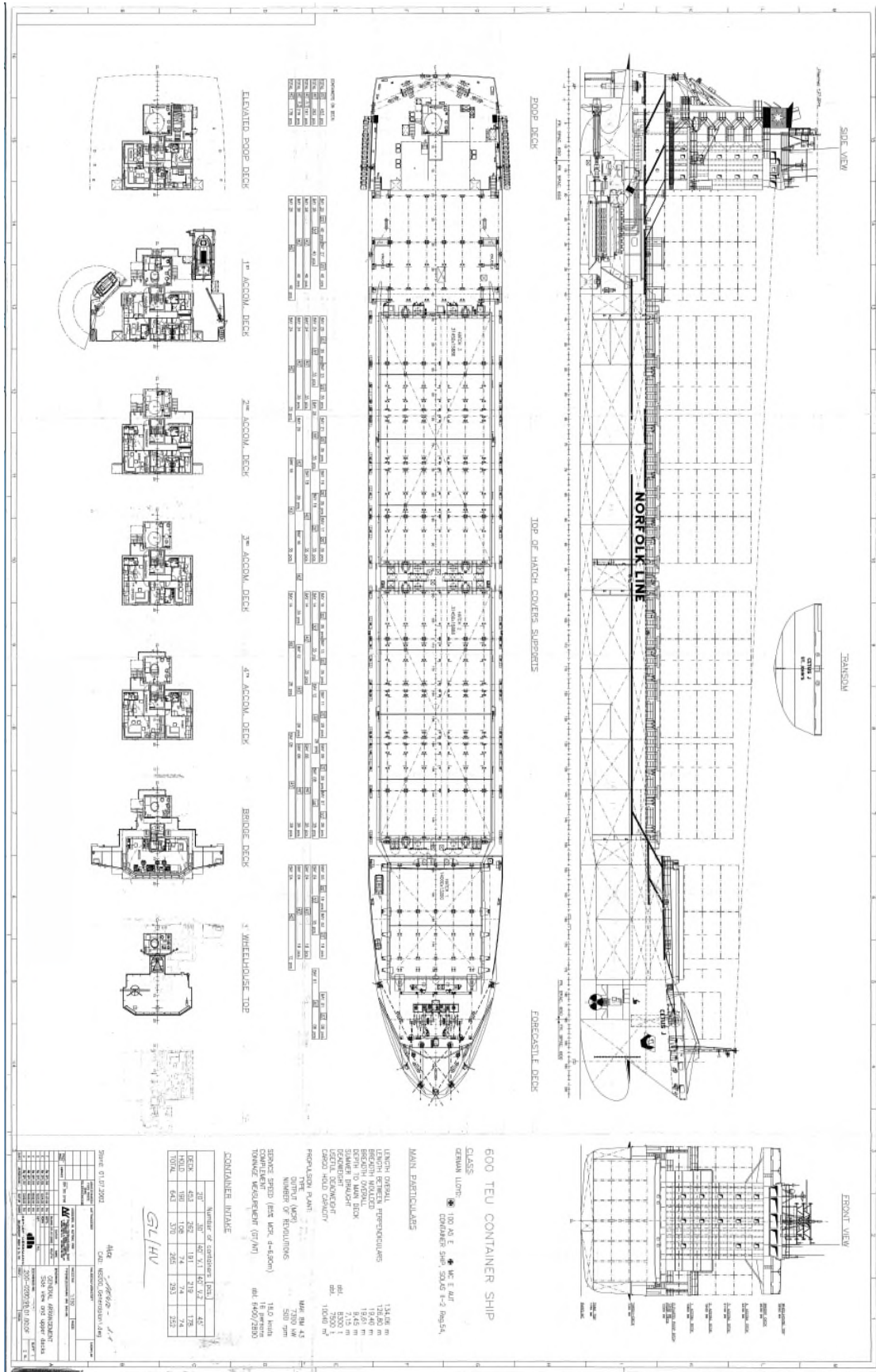

Figure 5: Corvus J general arrangement plan

2.2 Condition of vessel

2.2.1 Both vessels held the necessary statutory certification required under International Conventions, all of which were in a valid condition.

2.2.2 The Baltic Ace fulfilled the required surveys mandated by International Conventions and as described under the Harmonised System of Survey and Certification A.1053(27) as amended, with the following completion dates:

Intermediate Survey	April 2010
Annual Survey	May 2012
Renewal Survey	August 2012

2.3 Crew Particulars

Baltic Ace

2.3.1 At the time of the incident, on board the Baltic Ace, the vessel had a complement of 24 crew. The crew were made up of the following nationalities: 11 Polish, 2 Ukrainian, 1 Bulgarian and 10 nationals of the Philippines. The vessels Safe Manning Document (SMD) was issued by The Commonwealth of the Bahamas on the 25th March 2009.

2.3.2 The vessel met the requirements of the SMD and was provided with additional personnel in all departments. In particular the vessel had 5 Deck Officers; Master, Chief Officer, Second Officer and two 3rd Officers. This resulted in a watch-keeping routine of 4 hours on watch and 8 hours rest both in port and whilst underway. Consequently both the Master and Chief Officer were available to support the bridge watch-keeping Officer, as and when required, with no known detrimental effect on hours of rest.

2.3.3 The Master (35 years of age) a Polish national held a Masters unlimited Master Mariner Certificate at the management level (II/2)¹ required by the Standards of Training, Certification and Watchkeeping (STCW) issued by the Polish Maritime Authority and endorsed by the Commonwealth of the Bahamas and was duly recognized in accordance with the provisions of Regulation I/10 of the STCW 1978 (as amended) convention. He had started his career as a Deck Officer in 2001 before advancing through the Company to Chief Officer on board the sister vessel to the Baltic Ace. In February 2012 he was promoted to Master of the Baltic Ace and was working a 10 week on, 10 week off back-to-back rotation. At the time of the collision he was approaching his fifth week.

¹ Specification of minimum standard of competence for Masters and Chief Mates on ships of 500 gross tonnage or more.

- 2.3.4 The 3rd Officer (37 years of age) a Polish national held a Deck Officer Class 3 (Officer in Charge of a Navigational Watch) certificate issued by the Polish Maritime Authority and a Certificate of Competence endorsed by the Commonwealth of the Bahamas in accordance with the provisions of Regulation I/10 of the STCW 1978 convention. Since qualifying as an Officer in 2010, he had served a total of four contracts, two of which were on the sister vessel of the Baltic Ace. He had joined the Baltic Ace in September 2012 and was assigned 4 – 8 bridge watch.
- 2.3.5 The Deck Cadet (24 years of age) on watch at the time of the collision was a Bulgarian national. He joined the Baltic Ace in September 2012 in order to gain practical experience towards his deck qualification having completed his theory based studies in June 2012. He was working a flexible routine under the supervision of various crew members in order to facilitate training requirements. This routine included a 2 hour period on the bridge under the supervision of the 3rd Officer between 1800 and 2000 daily.

Corvus J

- 2.3.6 The Corvus J operated a three watch manning system shared between the Master, Chief Officer and 2nd Officer maintaining watch-keeping routine of 4 hours on watch and 8 hours rest both in port and whilst underway. The watch-keeping schedule complied with the statutory minimum requirements for hours of rest as specified in STCW Convention A-VIII/1².
- 2.3.7 It cannot be verified whether the Company's Safety Management System (SMS) was prescriptive in respect of watch-keeping schedules or not. It is understood that watch-keeping schedules were to be left to the discretion of the Master to organise watches in order to comply with the Maritime Labour Convention 2006, as amended, in particular regulation 2.3 prescribing hours of work or rest.
- 2.3.8 The Master of the vessel held a Masters unlimited Master Mariner Certificate at the management level (II/2) required by STCW.
- 2.3.9 The Chief Officer (67 years of age) on watch at the time of the collision held a Chief Officer Unlimited Certificate of Competency issued by the Polish Maritime Authority with an STCW Endorsement issued by the Cypriot Maritime Authority. He had served in the capacity of Chief Officer since 1992 and had sailed on board the Corvus J since October 2012.

² A-VIII/1 Standards regarding watchkeeping, Fitness for duty.

3 NARRATIVE OF EVENTS

3.1 All times are given in Coordinated Universal Time (UTC) unless annotated otherwise and in the style of the 24 hour clock. If other references require a local time to be quoted it will be denoted by description or with the differential in brackets e.g. (UTC+1): denoting European Standard Time in winter.

3.2 Baltic Ace – departure from Zeebrugge

3.2.1 At 1300 on the 5th December 2012, on completion of cargo operations, the vessel departed from its berth in the port of Zeebrugge under the direction of a harbour pilot. The vessel was loaded with a cargo of 1,417 cars and had a sailing draught of 7.20m forward and 7.30m aft with a metacentre height (GM) of 0.97m. Due to the heavy weather the Master wanted to redistribute the water ballast in order to achieve a trim by the stern of 0.5m. The Chief Officer (C/O) carried out the redistribution and the following draughts were recorded: 7.00m forward, 7.50m aft with a 1.20m Metacentric Height (GM).

3.2.2 At 1430 the vessel departed the lock at Zeebrugge and proceeded to sea, the C/O reported to the Master that the vessel was ready for sea passage with all vehicle lashings and mooring equipment secured and watertight doors closed.

3.2.3 At 1605 the vessel was clear of the harbour limits and the pilot had disembarked at the Wandelaar Pilot station. The planned navigational route was in accordance with Admiralty Sailing Directions³ and intended to utilize the charted Traffic Separation Schemes (TSS) adopted by the International Maritime Organisation (IMO), as listed within Annual Notice to Mariners No. 17 (NP247). Due to high traffic density in this region, the Master decided to maintain Control (Conn) of the vessel, increasing speed to a service speed of 19kts and keep the vessel in hand steering until finally past and clear Westhinder anchorage at approximately 1650.

3.2.4 The 3rd Officer, who was present on the bridge supporting the Master, in preparation to relieve the Master of control prior to continuing with his watch until 2000 in the capacity of Officer of the Watch (OOW). On the bridge at this time was the Deck Cadet who had relieved the helmsman in order for him to go for his meal and then assume the role of lookout once the vessel had transitioned from hand steering to auto pilot.

3.2.5 Having handed control to the 3rd Officer the Master left the bridge at 1700 and proceeded aft to the ship's office located on deck 9. Prior to leaving the bridge he recalled checking the panel indicating the status of the watertight

³ NP 28 Dover Strait Pilot

doors and hull openings, all indicator lights were green indicating everything was closed and cleated.

- 3.2.6 At some point during the 3rd Officer's watch and prior to the collision the Master returned to the bridge. The reason cannot be recalled at the time of interviewing the Master, however, the Master confirmed that the OOW had acquired the Corvus J on the starboard Automatic Radar Plotting Aid (ARPA) and was informed that the vessel was crossing ahead at 1nm (closest point of approach) with no other vessels in the vicinity that gave the Master a cause for concern. The Master then returned to the ship's office.

3.3 Corvus J – route from Grangemouth to Antwerp

- 3.3.1 The Corvus J was part loaded with a cargo of 73 containers in holds and on deck (one tier only) whilst underway from Grangemouth, Scotland to Antwerp, Belgium on the evening of the 4th December. The vessel provided continuous coasting cycle as a feeder container vessel from the principal ports of Europe.
- 3.3.2 Prior to departing Grangemouth the vessel had been alongside for 36 hours while conducting cargo operations. On departure the sailing draught forward was 4.5m and 6m aft.
- 3.3.3 At 1600 the Chief Officer relieved the 2nd Officer as OOW. It was a common operating procedure for the OOW to be on the bridge alone, as was the case on the 5th December.
- 3.3.4 At 1757 on the evening of the 5th, the Corvus J rounded the DW-W buoy at the South West extremity of the deep water anchorage onto a South Easterly course in order to pass through the North Hinder Junction precautionary area towards Steenbank Pilot station. Having been previously advised that there would be a delay in the planned pilot embarkation time, the OOW reduced the vessels speed from 14.0kts to 12.5kts in order to make the pilot boarding station by 1930.
- 3.3.5 The weather conditions did not hamper the OOW ability to visually sight three vessels approaching the precautionary area, and had identified the Baltic Ace as being *“on the starboard side of the other two vessels and was overtaking the other two vessels”*.⁴

3.4 Other vessels in the vicinity

- 3.4.1 M.v Ice Point was en-route to Rotterdam, Holland and situated to the north-west of the Baltic Ace, the Baltic Ace was making good a speed of 19kts and

⁴ Extract taken from the Chief Officer's witness statement

although converging with the Ice Point, it had a sufficient speed advantage and therefore deemed to be the overtaking vessel.⁵

- 3.4.2 M.v Panagia was underway on a parallel course to Ice Point at a range of 1.5nm on her starboard quarter; this vessel was not close enough to play an active role in the events leading to the collision but was later involved in the subsequent search and rescue (SAR) operation.
- 3.4.3 Another vessel, the m.v Komarno was 1nm astern (starboard quarter) of the m.v Panagia on a parallel course, north east bound. It was not close enough to witness the events leading up to the collision but was involved in the search and rescue operation.
- 3.4.4 F.v Martha Lena (SL3) was operating ahead and to starboard of the Baltic Ace and in the vicinity of the intended passage of the Corvus J. The vessel was engaged in trawling and had her gear extended astern and was heading in a southerly direction on the southern extremity of the precautionary area. The Master of the vessel witnessed the collision and provided a statement to the Dutch Safety Board Marine Accident Investigation Branch. In addition the vessel participated in the search and rescue operation.
- 3.4.5 A second fishing vessel f.v Zeldenrust (OD6) was in the vicinity at the time and assisted with the search and rescue operation but was not in any way in a position to effect the decision making process of the watch-keepers onboard the Corvus J or the Baltic Ace.

⁵ COLREGS Rule 13 Overtaking “a vessel shall be deemed to be overtaking when coming up with another from a direction more than 22.5° abaft her beam, that is such a position with reference to the vessel she is overtaking, that at night she would be able to see only the sternlight of that vessel but neither of her sidelights.”

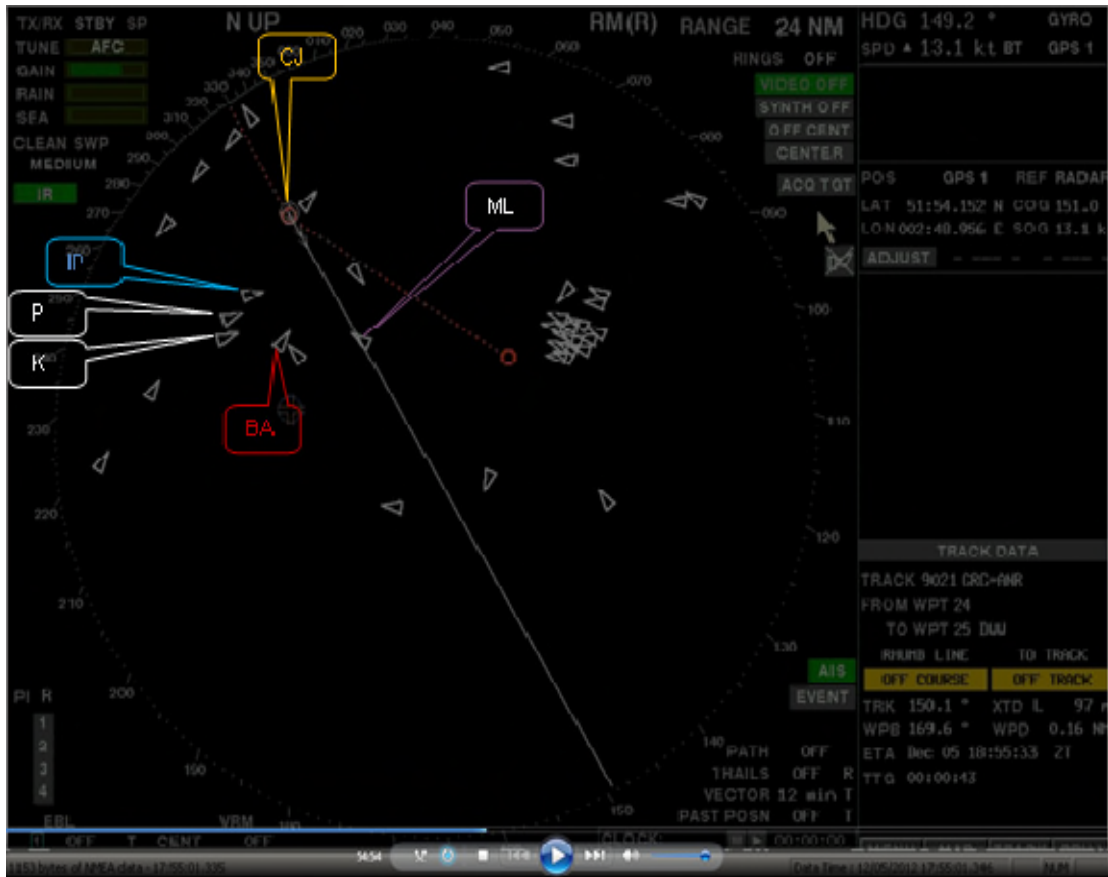

Figure 6: 24NM Radar screen picture at 17:55: Vessels: ICE POINT (IP), PANAGIA (P), KOMARNO (K), BALTIC ACE (BA), MARTHA LENA (ML) Source: Corvus J VDR (CJ)

3.4.6 According to the Chief Officer’s statement, there were two radars onboard and operational, the first (starboard) set to 24nm range scale (see figure 6) and the second (port) set to 6nm with an offset centre in order to focus further ahead of the vessels. Both radars were ARPA and AIS capable.

3.5 Timeline of events leading to the collision

3.5.1 The following data and figures have been assembled by integrating data provided by Baltic Ace, Corvus J, Ice Point and Martha Lena obtained from the following equipment devices: radar, Voyage Data Recorder (VDR), AIS and rudder angle indicator - superimposed onto an electronic chart.

3.5.2 At 1808 Baltic Ace and Corvus J were 3nm apart, with a CPA of 0.5nm. The bearing from the Baltic Ace to Corvus J was moving very slowly right⁶, indicating that the Corvus J was intending to cross ahead of the Baltic Ace. Both vessels remained at service speed giving a relative approach speed of 31kts. To provide perspective, the vessels closed one another at a rate of

⁶ When one vessel is viewed from another, providing a steady bearing is not maintained (unless the vessels are too close to one another or are exceedingly large), the two vessels will always pass one another. If the bearing movement is very slow or steady the probability of both vessels coming into contact with one another is considered likely unless the vessels are on opposing headings.

0.5nm every minute, which represents the vessels reaching their closest point of approach in 6 minutes having covered a distance of 3.18nm.

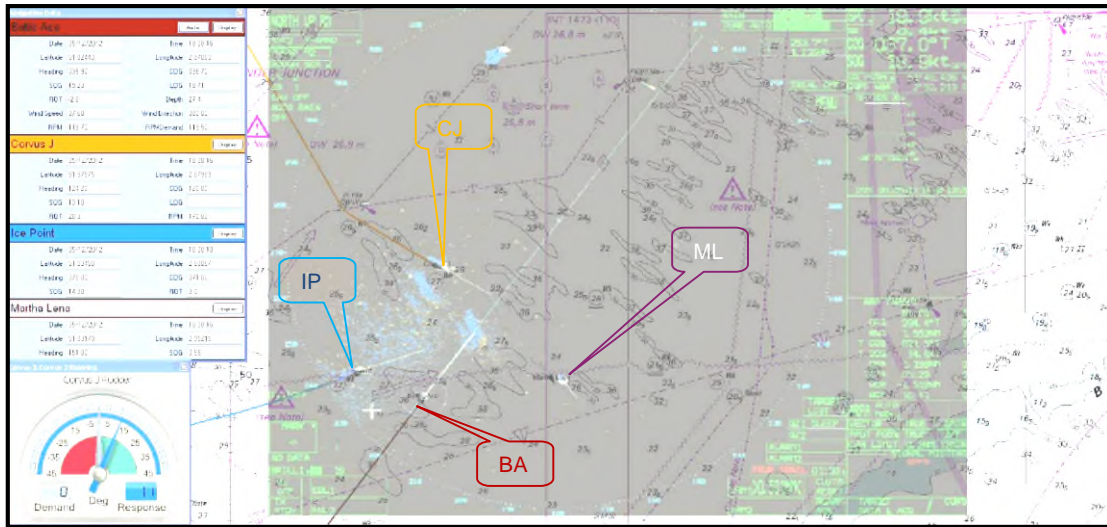

Figure 7: Position of vessels at 18:08:16

- 3.5.3 The OOW had identified the Corvus J and acquired the vessel on ARPA at approximately 12nm and later visually by the sight of her masthead lights. The first acknowledgement by the OOW onboard the Baltic Ace as to the CPA and the developing situation with the Corvus J came at 18:08:45, when the OOW was heard to say on the bridge audio recorder “*it’s close, 5 cables before my bow*”.
- 3.5.4 Having recognised that a close quarters situation was developing with the Corvus J, at 18:09:31 the Baltic Ace called the Corvus J on VHF CH 16 to establish a working channel. Whilst the OOW on board Baltic Ace establishes communication, the Corvus J commenced an alteration of course to starboard from 129° to 152° in what is believed to be in accordance with the vessel’s passage plan.



Figure 8: Position of vessels at 18:09:22

3.5.5 Both vessels agreed to communicate on VHF working channel 06 (this channel was used as the working channel between the two vessels for all further communications). At 18:09:40 the Baltic Ace OOW requested the Corvus J to maintain course “*So I see that you pass my bow very close so keep your course and I alter my course a little to port, OK, I alter to port*”, Corvus J agrees to the solution “*Yeah OK, because I am departing behind one vessel after you go behind me, OK thank you very much*”. The final acknowledgement between the two vessels as to the intended close quarters avoidance was confirmed by the OOW of the Baltic Ace stating “*Yeah I see, I alter to port, OK thank you, back to 16*”.

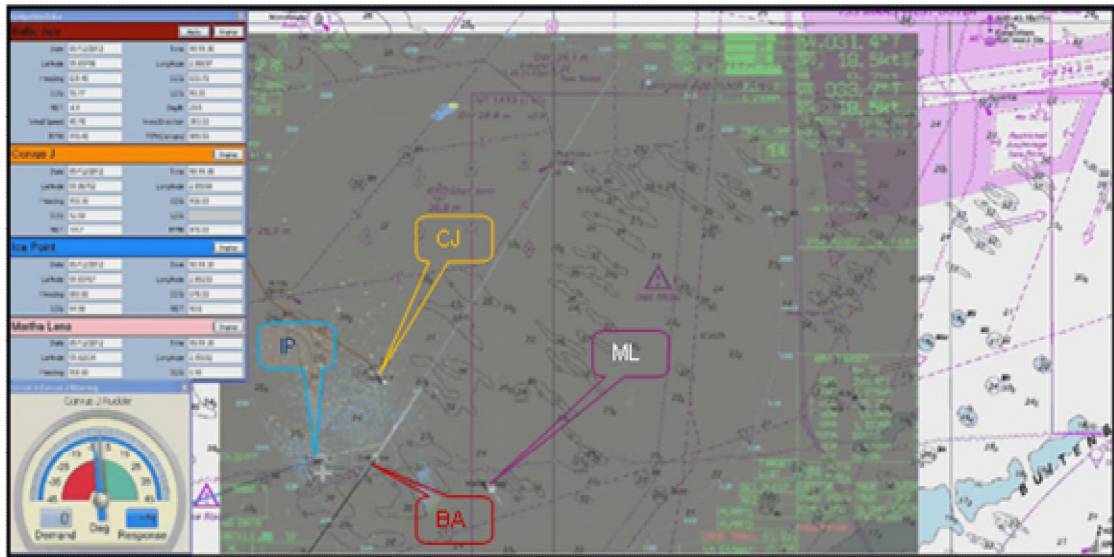

Figure 9: Position of vessels at 18:11:30

3.5.6 Between 18:09:40 and 18:11:28 the Baltic Ace altered course to port by 2° from 037° to 035° and maintained a speed of 18.5kts. Over the same period, the Corvus J commenced altering to a new course of 152° and maintained a speed of 12.5kts having altered from 129° at 18:09:55.



Figure 10: Position of vessels at 18:12:22

3.5.7 At 18:11:28, the Baltic Ace called the Corvus J having detected the alteration of heading by the Corvus J soon after the first VHF conversation. The call was to seek clarification about the change in course and was recorded as follows: Baltic Ace OOW asks “*So I see you alter your course to starboard now yes?*” Corvus J explains with the following: “*Yes just now, I will keep the course, because another vessel crossing my stern, she is going there behind me. If possible you change a little bit to port after we be fine*”Baltic Ace OOW acknowledges and agrees to come further to port “*OK I go more to port OK*”.



Figure 11: Position of vessels at 18:12:50

3.5.8 Between 18:11:28 and 18:12:27 the Baltic Ace altered 4° to port whilst the Corvus J maintained its course and speed. At 18:13:18 the Corvus J attempts to make VHF contact with the Baltic Ace, however, due to a conversation taking place on the bridge of the Baltic Ace at the time, the OOW did not respond to the Corvus J. The Corvus J repeats the transmission and successfully establishes communications with the OOW and asks the Baltic Ace “*you keep your course like that*”, the Baltic Ace replies “*yes I keep like that*”.



Figure 12: Position of vessels at 18:13:12

3.5.9 At 18:13:26 the Baltic Ace began an alteration of course to port, starting at 021° and by 18:14:40 had reached a heading of 010°. In the same period the Corvus J commenced a turn to starboard using 15° of rudder, from 152° to 207° which was the recorded heading at the time of impact. No reduction in speed was evident on either vessel as the distance between the two vessels closed at a speed of 31kts.

3.5.10 As Corvus J commenced an alteration of course to starboard, the OOW on board the Baltic Ace switched the steering to manual and turned the wheel to port “I did not put it hard over immediately but very shortly afterwards I put the wheel full to port”.



Figure 13: Position of vessels at 18:13:50

3.5.11 At 18:14:18 the OOW on the Baltic Ace stated that the crossing distance between the two vessels was now 2 cables ahead. At this point both vessels

were in their respective turns, the Baltic Ace was continuing to port and the Corvus J to starboard.

- 3.5.12 At 18:15:04 the OOW on board the Baltic Ace placed the rudder hard over to port. At the same time the OOW on board the Corvus J reversed the rudder from 15° starboard to hard to port and reversed the propeller pitch from 65% ahead to 55% astern.

3.6 Collision and Separation

- 3.6.1 At 18:15:17 the Corvus J collided with the starboard side of the Baltic Ace in vicinity of frame 165. On impact the Baltic Ace was traveling at a speed of 15.1kts on a heading of 322°, the Corvus J was traveling at a speed of 9.2kts on a heading of 207°. The Corvus J rotated clockwise as it travelled along the starboard side of the Baltic Ace penetrating the side shell plating with the bulbous bow and bow structure.

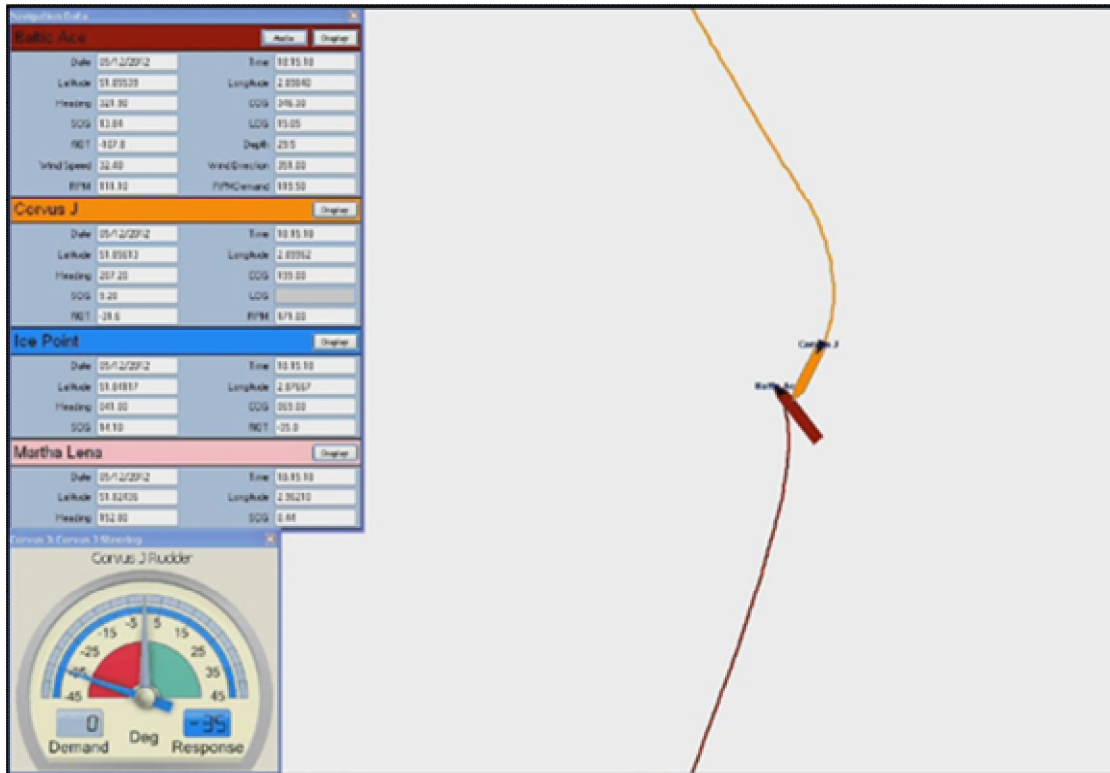

Figure 14: Point of collision at 18:15:17

- 3.6.2 Immediately after the impact at approximately 18:16 both vessels separated from one another and stopped in the water. With no prior warning or contact from the OOW on their respective vessels, the Masters of both vessels had arrived on their respective bridges immediately after the impact to assess the situation. Even at this early stage the Baltic Ace was rapidly listing to starboard as it began to take on water through the breach in the side shell plating.

- 3.6.3 The Master of the Baltic Ace determined after the collision that the vessel was in an unrecoverable situation and as a result gave the order to abandon ship shortly before 1817.
- 3.6.4 The Baltic Ace VDR continued to record for a short period after the collision, during that time a repeating whistle signal can be heard. Concurrent with the whistle signal is the sound of falling objects consistent with a rapid change in inclination. The VDR recording on board the Baltic Ace stops recording at 18:17:01.
- 3.6.5 Immediately after the collision the Master of the Corvus J instructed the C/O to investigate the watertight integrity of the vessel and determine the extent of the damage. The result of the search concluded that although the vessel had sustained significant damage to the shell plating and bulbous bow no breach of the shell plating was observed. The vessel was able to remain on scene and render assistance to the SAR operation.

3.7 Search and Rescue Operation

- 3.7.1 The Netherlands Rescue Coordination Centre (RCC) located in Den Helder, had witnessed the collision on radar. The position of the collision was in an area in which the Netherlands has responsibility for rescue coordination but is close to the Belgian sector.
- 3.7.2 In addition to the vessels referred to in section 3.4 above, the search and rescue operation was coordinated by HNLMS Friesland (Royal Netherlands Navy Offshore Patrol Vessel) which established itself as the On-Scene-Coordinator (OSC). Further, the rescue operation received assistance from both Belgian and Dutch SAR helicopters.
- 3.7.3 At 18:21:54 the Baltic Ace broadcasted an emergency message by Digital Selective Calling (DSC) recorded at The Netherlands Rescue Coordination Centre (RCC). VHF communication subsequently followed between the Baltic Ace and the RCC whereby vessel, incident details, location and vessel condition were provided.
- 3.7.4 The Corvus J engaged with RCC providing details of the condition of the vessel. Simultaneous to this m.v Panagia called the Baltic Ace on VHF Ch16 requesting the exact location, the Baltic Ace transmitted the following “*drifting in position 51°50.30N 002°52.7E*” and additionally stating that “*the vessel was sinking with a 40° starboard list after a collision with another vessel*”. The RCC then told Baltic Ace that they were sending help and asked them to stand-by as long as possible on VHF Ch16. Baltic Ace acknowledged but no further transmissions were received.
- 3.7.5 At 18:28:07, the first MAYDAY relay broadcast was transmitted by RCC having reacted to the DSC alert received from the Baltic Ace.

3.7.6 RCC having established, and confirmed via VHF with the Baltic Ace the extent of the damage that they did not know the other vessel involved in the collision. After a brief discussion on VHF CH16 with Ice Point, and requesting their assistance, to which Ice Point complied, Corvus J called RCC and confirmed again that they were the other vessel involved in the collision.

3.8 Evacuation from Baltic Ace

3.8.1 At the point of impact, the crew were displaced in the following locations: 3 crew in the Engine Control Room, 14 crew located in the accommodation/communal areas, 2 crew on the bridge, Master in the ship's office and the Chief Officer roving in vicinity of decks 9 & 10. Of the 24 crew on board, the location of 3 crew members at the time of impact cannot be accounted for.

3.8.2 The Master, C/O and Chief Engineer were present on the bridge in the moments prior to the vessel capsizing. Due to the angle of list the Master and C/O soon found themselves on the starboard bridge wing, with the water rising against the outside of the windows. The bridge windows eventually imploded and the Master escaped to the open deck. The Chief Officer and Chief Engineer did not manage to escape to the open deck; it is probable that the influx of water was so severe that they may have been swept aft, into the accommodation area.

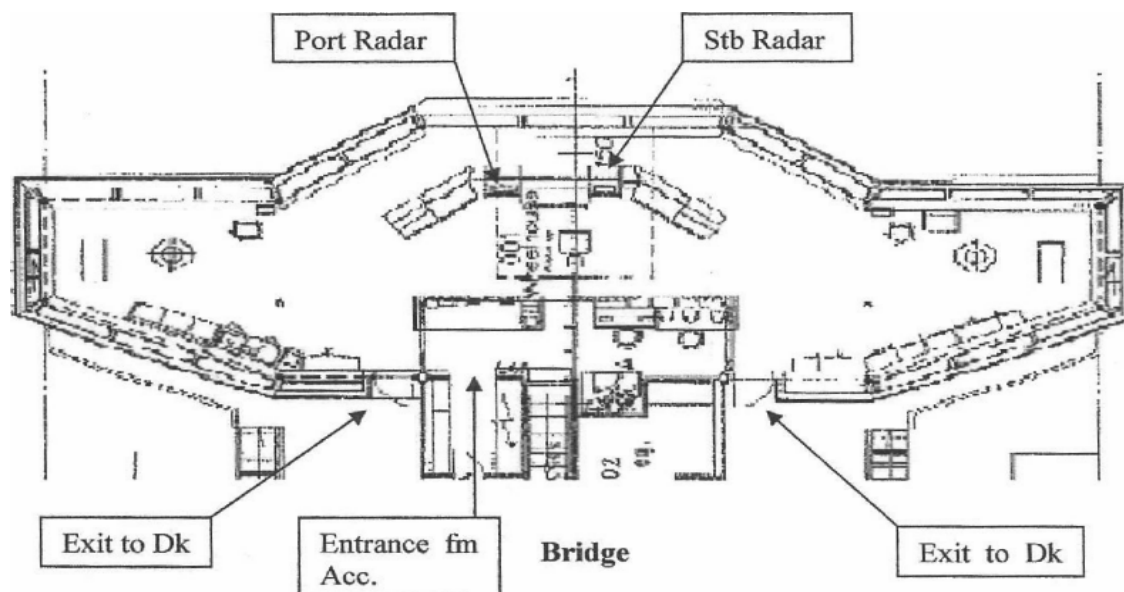

Figure 15: Baltic Ace bridge layout

3.8.3 Of the 13 surviving crew members, 11 entered the sea and boarded the life rafts directly from the water. Accounts of survivors told of walking on the bulkhead of the accommodation block, which was becoming increasingly horizontal as the vessel adopted a 90° list prior to sinking.

- 3.8.4 One AB was found to be occupying the vessel's port lifeboat (No.2), which floated free when he activated the on-load release gear as it became buoyant. It is understood that the inclination of the lifeboat was the same as that of the vessel, with which it was attached. Once released and clear of the fall blocks and links, it righted itself, and floated clear of the vessel remaining watertight throughout. Once upright, the AB was able to start the engine and manoeuvre it clear of the vessel. Once clear the AB shut down the engine to assess the situation, at that point the lifeboat was struck by the bow of the Corvus J. The AB had several failed attempts to successfully launch a parachute flare, eventually a hand flare was used to gain the attention of the Corvus J. A life line was then provided and hauled the AB free from the lifeboat and provided victuals and warm clothes once recovered on board.
- 3.8.5 All survivors entered the sea with the exception of the AB who used the port lifeboat. Of those, 11 were able to reach two life rafts and board them. One survivor, the 4th Engineer, who did not manage to reach a life raft but managed to reach a lifebuoy, remained in the water for approximately 2 hours before being recovered by m.v Panagia.
- 3.8.6 Of the 11 crew to be known not to have survived, 5 bodies were recovered within 24 hours of the collision and a further 3 crew were reported⁷ to have been recovered since. However, 3 remain missing and presume deceased.

⁷ Information provided by STAMCO, managers of the Baltic Ace

4 ANALYSIS

4.1 Aim

- 4.1.1 The purpose of the analysis is to determine the contributory causes and circumstances of the accident as a basis for making recommendations to prevent similar events occurring in the future.
- 4.1.2 Evidence gathered from the following sources formed the basis of our analysis and subsequent findings. Interview statements from the crew of the Baltic Ace have been obtained via the lawyers acting on behalf of the Owners. The interview statements taken from the crew of the Corvus J have been provided by Cypriot Department of Merchant Shipping as the Bahamas Maritime Authority's on-scene investigator was denied access to the interviews of the Corvus J crew. Additional evidence provided by the Netherlands RCC, VDR data from both vessels, vessel damage and stability analysis provided by London Offshore Consultants (LOC) under instruction from the BMA and witness statements from personnel on board vessels operating in the vicinity.

4.2 General Observations

- 4.2.1 The quantity of evidence made available to the Bahamas Maritime Authority has enabled the Casualty Investigation team to conduct a detailed analysis of the events leading up to the collision, abandonment and search and rescue operation.
- 4.2.2 The Baltic Ace comprised of 10 decks, with the navigation bridge arranged forward on deck 10. Deck 10 is the second deck of the accommodation block arranged on top of 8 cargo decks. The engine spaces were arranged aft and below deck 4, which served as the main cargo deck and watertight subdivision. Access to the cargo holds was through a stern and quarter ramp both arranged on deck 4. Access to the cargo decks above and below deck 4 was arranged through a system of internal ramps. The main ramp leading from deck 4 down to the lower hold and between decks 3, 2 and 1 was arranged as a hydraulically operated hatch cover. When the hatch cover was closed it created a gas and watertight seal between the main deck and the lower hold. The hydraulically operated ramp to deck 6 again, created a gas tight seal between decks 4 and 5 and decks 6 to 8.
- 4.2.3 Car carrier capacity is calculated in accordance with a standard unit (RT-43) which is based on the area occupied by a 1966 Toyota car. The cargo capacity was 2,132 RT-43 unit size cars that would occupy 17,664.1m² of deck area. The vessel sailed on the 5th December at 66.5% capacity.

4.2.4 Prior to the collision, both vessels aligned themselves with the general direction of traffic flow and adhered to COLREGS governing the safe passage of vessels operating in or near the terminations or precautionary areas of a TSS as illustrated in figure 15. Prior to the collision, there is no evidence to suggest that either vessel had any difficulty navigating this particular sea area.

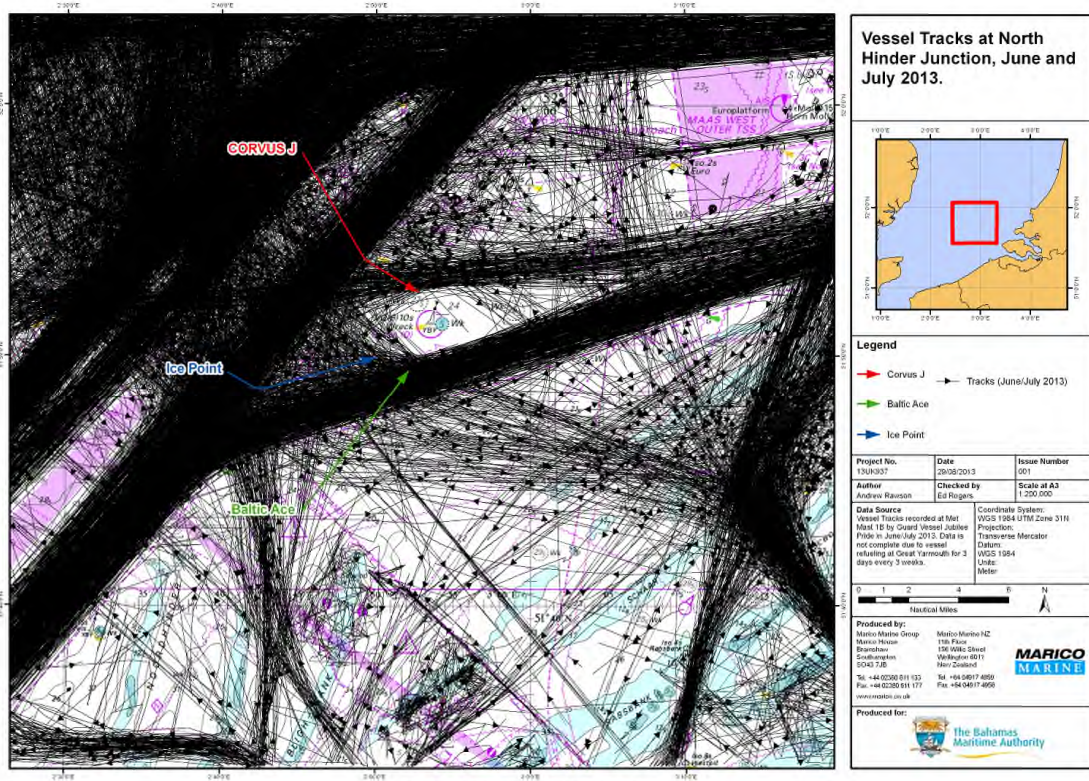

Figure 15: Typical tracks at North Hinder Junction with tracks of Baltic Ace, Corvus J and Ice Point superimposed, illustrating that planned courses were logical - Source: Marico Marine

4.2.5 It can be determined from Class, Port State Control (PSC), Flag and Company survey and inspection records that the crew conducted the necessary emergency training and drills in accordance with SOLAS III/19, as such there is no reason to believe there were any issues regarding competence in the operation of Life Saving Appliances (LSA). Abandon ship drills were conducted regularly under the Chief Officer’s direction in his capacity as Safety Officer. His daily working routine generated sufficient spare capacity to enable him to conduct safety drills regularly on board.

4.3 Manning on board Baltic Ace and Corvus J

4.3.1 Officers of the Watch on board Baltic Ace and Corvus J were qualified and endorsed to a standard that requires a “thorough knowledge of the content, application and intent of the International Regulations for Preventing Collisions at Sea, 1972, as amended” and the competence evaluated against the ability of each OOW to be in a position to take “action to avoid a close

encounter or collision with other vessels in accordance with COLREGS 1972, as amended”⁸.

- 4.3.2 When considering the roles and responsibilities of the Master or Chief Officer specifically in regard to providing support and advice to the OOW, there is one limitation that is commonplace on board most vessels – that is, it is unlikely the Master or Chief Officer will be aware if their services are required unless the OOW requests it.

Baltic Ace

- 4.3.3 The watch-keeping routine on board the Baltic Ace was conducive towards relatively short sea passages and quick cargo turnarounds. The watch routine allowed the OOW to develop professionally whilst affording adequate supervision from the Master or Chief Officer if required.
- 4.3.4 The BMA cannot determine to the full extent necessary whether any aspect of fatigue affected the watch-keepers ability to fulfil their responsibilities. With the three watch system in place and both the Master and Chief Officer day-working, it could be considered that the Company had implemented a policy, the purpose of which to mitigate the effect of fatigue.
- 4.3.5 The watch routine indicated a responsible attitude given the developing circumstances of a vessel entering a precautionary area. The assignment of a Deck Cadet designated as lookout, and an AB on standby (in the crew mess) to complement the bridge team if the OOW deemed necessary to undertake either lookout or helm duties as required, demonstrates adequate precaution.

Corvus J

- 4.3.6 The vessel had three deck Officers, including the Master, maintaining a 4 hour on, 8 hours off watch routine which complied with the statutory minimum requirements for hours of rest as specified in STCW A-VIII/1⁹. In addition, the hours that were actually worked by the OOW over the preceding 24 hour period ensured as a minimum, that the statutory hours of rest were maintained. The evidence provided cannot categorically conclude whether or not the Chief Officer felt fatigued in any way. As the OOW was alone on the bridge, there is no way of verifying the physical and mental wellbeing of that individual during that watch period.
- 4.3.7 The Master, in the capacity of a watch-keeping Officer may have been limited in the level of support afforded to OOW during critical stages of any voyage particularly during periods where the Master was resting prior to taking a watch.

⁸ A-II/1 STCW (Master and Deck Department) – Navigation at the Operational Level

⁹ Chapter VIII Watchkeeping, Regulation VIII/1 Fitness for Duty

- 4.3.8 The OOW on board the Corvus J was keeping watch on his own. In a sea area known for high levels of traffic density, with a developing situation on the starboard bow, the OOW was at this time, left to potentially be required to manoeuvre the vessel, monitor bearings of other vessels visually, monitor ARPA, navigate and respond to VHF calls. This level of activity may have prohibited the OOW ability to summon assistance from another watch-keeper or fulfil any number of the many requirements to an adequate standard, in particular in keeping a proper lookout.
- 4.3.9 A proper lookout shall be “*maintained at all times*” in compliance with rule 5 of COLREGS, and shall serve the purpose of: “*I maintaining a continuous state of vigilance by sight and by hearing, as well as by all other available means...*” in accordance with STCW VIII/2¹⁰. The decision to appoint the OOW as the sole lookout during periods of darkness is not considered in compliance with the prescribed application of the regulation for the reason that “*the lookout must be able to give full attention to the keeping of a proper lookout and no other duties shall be undertaken or assigned which could interfere with that task*”¹¹.

4.4 Weather Conditions

- 4.4.1 Evidence provided by both witness statements indicate that the weather did not hinder either OOW’s ability in determining visual range or the direction either vessel was sailing. In addition there is no evidence to suggest that the weather conditions hampered the performance of the electronic navigational equipment on board.
- 4.4.2 The conditions experienced on the evening of the 5th December 2012 were not unusual and could be considered ‘typical’ for the English Channel and southern North Sea at that time of year. Average sea temperatures were in the range of between 07-10°C¹² with a wind chill of approximately -2°C based on 5°C outside air temperature. ‘The survival time for a crew member without an immersion suit but in working dress is approximately 25 minutes compared to an individual wearing an immersion suit which is estimated between 70-140 minutes.’¹³ It is clear that in typical winter conditions in the North Sea the provision of leak proof immersion suits with inherent thermal insulation together with sufficient buoyancy to keep the mouth clear of the water should significantly increase the probability of survival.
- 4.4.3 The prevailing North Westerly wind of 28 - 33kts generated a wave height of between 4 - 5.5m, moderate to rough sea state. Due to the reduced sea room and limited distance to generate significant fetch, compared with that of an

¹⁰ Part 4-1 Principles to be observed in keeping a navigational watch, para 14 – 16.

¹¹ Part 4-1 Principles to be observed in keeping a navigational watch, para 14 – 16.

¹² Admiralty Sailing Directions NP 28 Mean Sea Surface Temperature. A decrease of between 2-3° is possible with prolonged cold E winds in winter.

¹³ Data provided by Health and Safety Executive review of probable survival times for immersion suits in the North Sea. January 1996

ocean, the sea will appear confused, with steep waves being flattened at their peak causing significant sea spray and ‘white horses’. The resulting factor of this effect makes swimming very difficult even for the most accomplished swimmer. In addition, due to the short wave length, a person in the water may be visually obscured more frequently and as such the probability of being seen would be reduced.

- 4.4.4 By design the Baltic Ace is susceptible to the wind due to the high sides that enclose the car decks resulting in a large windage area. At the point of impact the vessel was exposed to 28-33kts of wind on the port beam which would have generated a slight starboard heeling moment prior to impact, the effect of this wind would have exaggerated the starboard list further after impact.

4.5 Action to Avoid a Collision

- 4.5.1 At 17:57 the Corvus J rounded the DW-W buoy heading South Easterly and at right angle to the general direction of traffic flow through the precautionary area. The Ice Point was at this time forward of its starboard beam at a range of 5nm and the Baltic Ace at 40° on its starboard bow at a range of 7nm. The Corvus J and the Baltic Ace were now considered to be on a steady bearing and approaching one another at a speed 31kts; under Rule 7(d) of COLREGS a risk of collision would have been deemed to exist. Under Rule 8(a) therefore, any action that is taken to avoid a risk of collision shall *‘if the circumstances of the case admit, be positive, made in ample time and with due regard to the observance of good seamanship’*.
- 4.5.2 As both vessels were greater than 50m in length their respective navigation lights would have been visible from one another at the following ranges: a masthead light, 6nm, a sidelight, 3nm¹⁴ therefore given that we know the visibility was in the region of between 5-8nm it can be assumed that the minimum visual identification from one another was 5nm.
- 4.5.3 However it was not until the vessels were 2.8nm apart with a CPA of 0.5nm that any obvious recognition of the developing close quarter’s situation existed. The OOW on board the Baltic Ace initiated contact with the Corvus J via VHF in order to resolve the developing situation; the result of that conversation formed the basis of an agreement which was in contravention of COLREGS.
- 4.5.4 In recognising that the OOW on board the Corvus J did not take *‘early and substantial action to keep well clear’* as required under Rule 16 – Action of the Give-way vessel, the OOW on board the Baltic Ace deemed it necessary to establish a line of communication to resolve the developing situation. COLREGS (34(d)) does provide clear and unambiguous direction to an OOW when in the event that two vessels approaching one another and either

¹⁴ Rule 22 Visibility of Lights, International Rules for Preventing Collisions at Sea compulsory requirement for vessels greater than 50m in length

‘vessel fails to understand the intentions or actions of the other, or is in doubt whether sufficient action is being taken by the other to avoid a collision... the vessel shall sound at least five short and rapid blasts on the whistle. Such signal may be supplemented by at least five short and rapid flashes’. In this instance however five flashes of the daylight signalling lamp¹⁵ would have been a more effective method of highlighting any misunderstanding as the whistle signal would not be heard at a sufficient range to be effective, given the environmental conditions.

- 4.5.5 Rule 34(d) was not used to clarify the intentions of the Corvus J, instead the OOW of the Baltic Ace engaged in VHF dialogue to determine a resolution. The watch Officers on both vessels were Polish however the working language for bridge-to-bridge safety communications was English in accordance with SOLAS V/14. The first VHF call took 46 seconds to complete in order to agree on a manoeuvre that ultimately contravened COLREGS proposed by the OOW on board the Baltic Ace and agreed by the OOW on board the Corvus J. Two experienced OOW’s, at a point when a risk of collision existed (confirmed visually and by radar), neither questioned the action recommended to resolve the situation.
- 4.5.6 The OOW on board the Corvus J, if having recognised that a risk of collision existed, should have taken action in compliance with Rule 8 and in particular the provisions of Rule 15 which would require the OOW, under the circumstances of the case to *‘avoid crossing ahead’* of the Ice Point and the Baltic Ace.
- 4.5.7 Instead, the OOW of the Baltic Ace identified that a solution to the developing situation might be achieved under the envelope of a mutual arrangement, an arrangement based on convenience and not in accordance with COLREGS.
- 4.5.8 The solution proposed by the Baltic Ace OOW would enable both vessels to maintain their planned intended course with minimal deviation. Under this proposed solution the Corvus J would not be required to alter course, despite being the ‘give-way’¹⁶ vessel, resulting in the stand-on vessel altering course towards the Corvus J with the intention of passing clear astern.
- 4.5.9 The action agreed resulted in the Baltic Ace altering course to port to pass astern of the Corvus J whilst the Corvus J was asked to *‘keep your course’*, however during this agreement the Corvus J had already begun making an alteration of course to starboard which resulted in reducing the CPA further.

¹⁵ In accordance with SOLAS V/19 paragraph 2.2.2 (Aldis Lamp)

¹⁶ As required in this instance, the ‘give-way’ vessel, directed to keep out of the way of another vessel shall, so far as possible, take early and substantial action to keep well clear. As defined by Rule 16 of COLREGS (Action by Give-way Vessel)

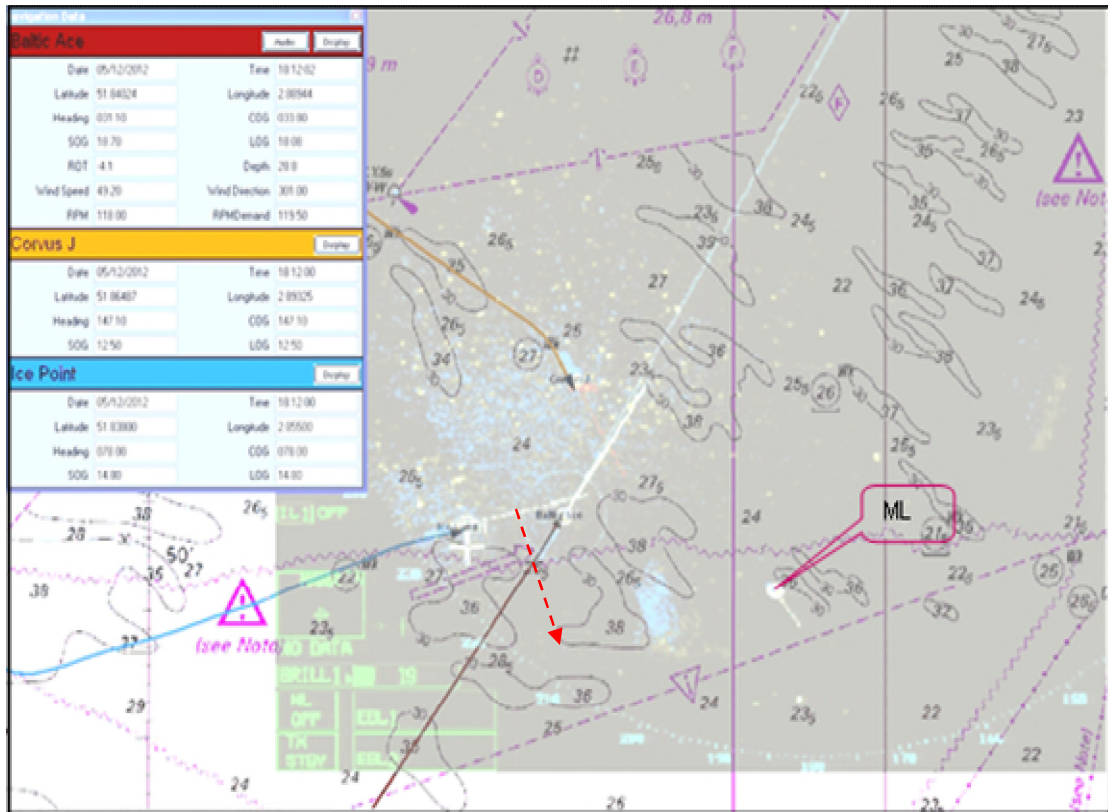

Figure 16: Time 18:12 Corvus J had altered at 18:09 to starboard

- 4.5.10 The alteration of course to starboard could have been intended in order to travel the least distance from the intended navigational plan while still maintaining speed in order to reach the pilot boarding station without delay. It is plausible that the Corvus J, in the knowledge that it was the give-way vessel decided to pass ahead of Ice Point but astern of the Baltic Ace as indicated by the relative red pecked line in figure 16.
- 4.5.11 It remains unknown whether this was the intention of the Corvus J OOW, the interview statement makes no reference to the objective or intended outcome of the starboard alteration of course but only refers to the action that was agreed verbally between the two OOW.
- 4.5.12 Under the provisions of Rule 8(e), both vessels were afforded the opportunity to take action *‘to avoid a collision or allow more time to assess the situation, a vessel may slacken her speed or take all the way off by stopping or reversing her means of propulsion’*. Although the Corvus J reduced speed, this decision was for the sole purpose of arriving at the pilot boarding station on time and was not sufficient to counter the relative speed of approach as both vessels altered course towards one another.
- 4.5.13 The VHF exchanges that ensued between the two Officers in the lead up to the collision became more ambiguous and confused as the two vessels drew closer to one another. Through analysis of the VDR data recordings this confusion appeared to become more evident as the situation developed given

that the intended actions of the Officers as communicated by VHF were not reflective of the action that was actually taken.

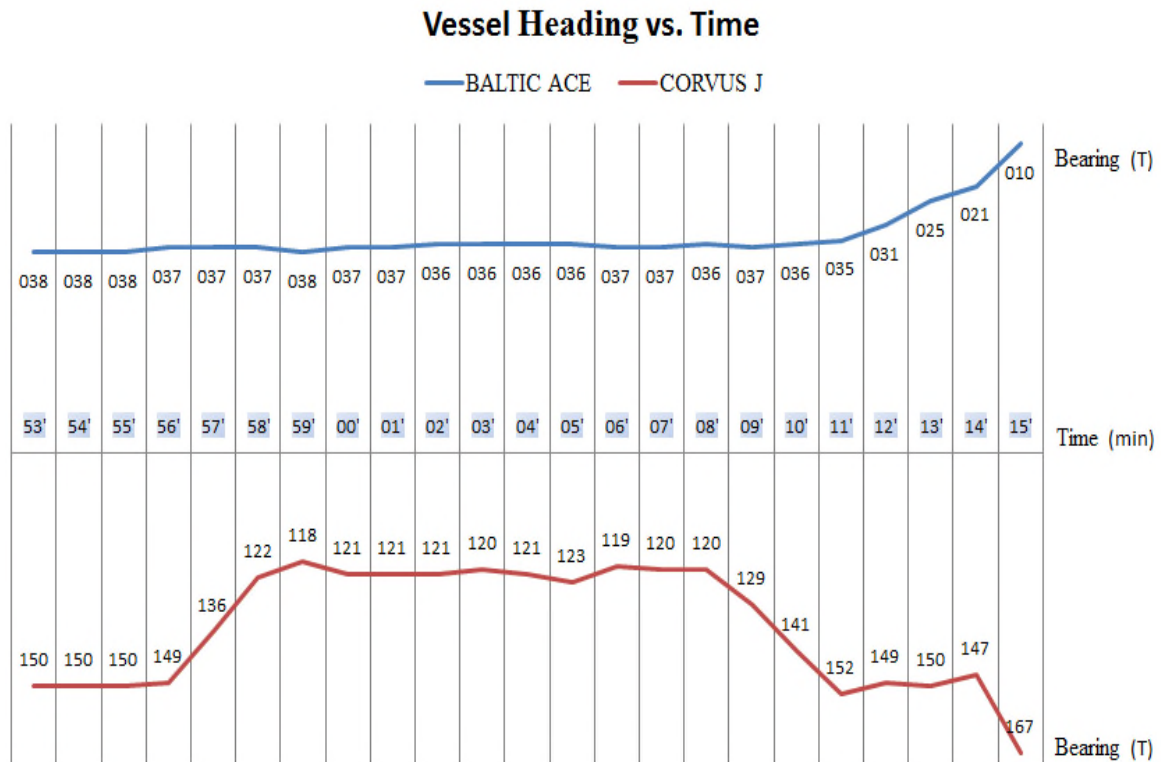

Figure 17: Baltic Ace and Corvus J heading between 17:53 and 18:15

4.5.14 Figure 17 displays the heading of both vessels over time. From this, it can be seen that at 18:10, the time the first VHF call between both vessels ended, neither vessel complied with the verbal agreement; Corvus J to remain steady on course and Baltic Ace to alter course to port. Although the Baltic Ace did commence an alteration of course to port, it could be deemed that 5° is not significant enough to be observed visually and questionable whether or not it may have been seen on ARPA. In addition and in accordance with COLREGS¹⁷, “any alteration of course and/or speed to avoid collision shall, if the circumstances of the case admit be large enough to be readily apparent to another vessel observing visually or by radar; a succession of small alterations of course and/or speed shall be avoided”. Further, the Baltic Ace, as the stand-on vessel in this crossing situation, shall in the event that a risk of collision exists “not alter course to port for a vessel on her own port side”.¹⁸

4.5.15 To understand the gravity of this intended action it may be worthwhile highlighting the actions required of the give-way vessel, the Corvus J. Rule 15 (Crossing Situation) identifies the situation between two power driven

¹⁷ Rule 8(b) Action to Avoid a Collision

¹⁸ Rule 17(c) Action by the Stand-on vessel

vessels as crossing when “the vessel which has the other on her own starboard side shall keep out of the way and shall, if the circumstances of the case admit, avoid crossing ahead of the other vessel”. This invariably leaves the OOW with three options; reduce speed, alter course or stop. The most efficient method providing time and sea room allow is to alter course, in doing so, the results of that course alteration shall ensure the vessel remains “well clear”. Therefore in a crossing situation an alteration of course to starboard is the most reliable method for ensuring the give-way vessel remains clear and does not impede the passage of the stand-on vessel.

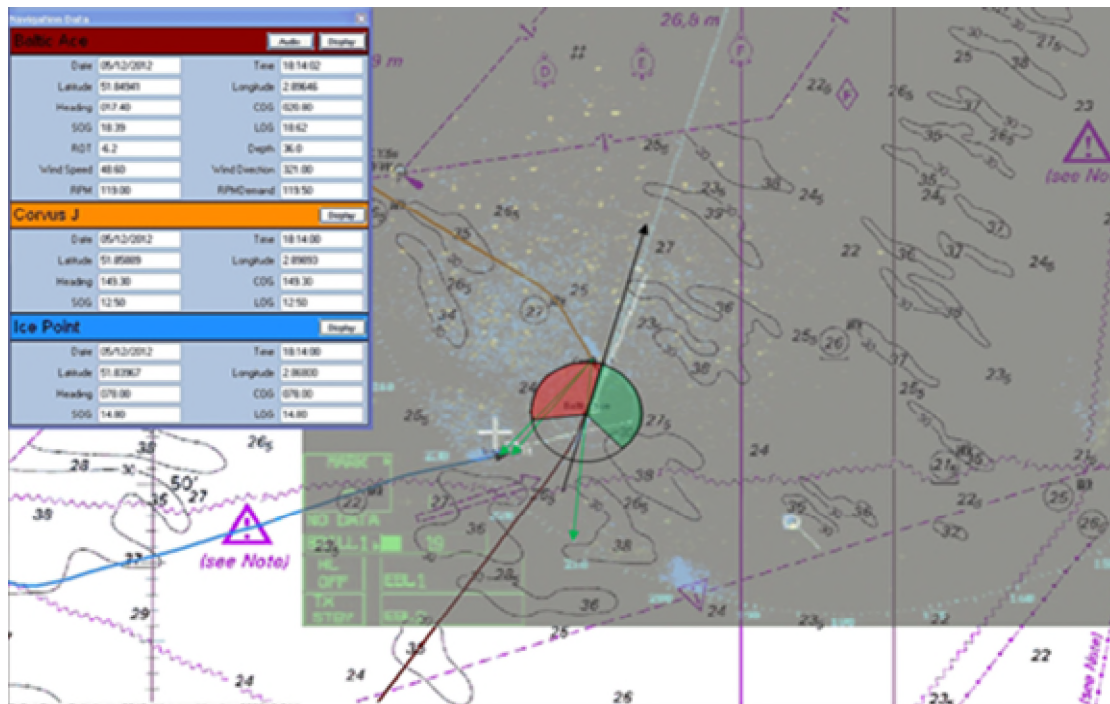

Figure 18: Relative positions of Baltic Ace and Corvus J at 18:14 illustrating Baltic Ace's light sectors visible to Corvus J

4.5.16 This resulted in a further VHF call to clarify the intentions of the Corvus J as the OOW on the Baltic Ace had recognised that the vessel was not maintaining a steady course. At this point the Corvus J steadies on course 149° while the Baltic Ace agrees to alter further to port. The Baltic Ace alters 6° to port. At 18:13 the Corvus J attempts to call the Baltic Ace, the Baltic Ace fails to respond to the first call, this can be heard on the VDR and in particular the OOW in discussion with the lookout about the course of action taken by the Corvus J and his interpretation of what was agreed “you keep your course OK, you can pass my bow, I think you alter to starboard”. Approximately 10 seconds later the Corvus J attempts to re-establish communications, which is successful, and the Corvus J requests confirmation that the Baltic Ace will maintain its course. At this point the Baltic Ace was steering 025° however immediately after the VHF transmission the vessel alters 4° to port. This alteration provokes another transmission whereby the Corvus J requests the Baltic Ace to reconfirm whether the vessel intends to maintain that course “you keep your course like that” to which the Baltic Ace confirms, “yes I keep it like that”.

4.5.17 At 18:13:50 the Corvus J initiated a turn to starboard, at the same time the Baltic Ace was executing a turn to port. It was not evident from the VDR records or interview statements whether the Corvus J OOW was aware of the continued alteration of course to port of the Baltic Ace. The voice recordings were ambiguous and difficult to deconstruct, it appears from this evidence that the OOW on board the Corvus J believed the Baltic Ace's heading was steady, affirmed by the final VHF conversation. The bridge voice recorder did record interference, and on occasion it was difficult to distinguish what was being said between the two Officers of the Watch. The OOW on board the Corvus J provided a statement to the Cypriot authorities where he states *"later when I saw danger I called the Baltic Ace but without reply, it is unknown what time this transmission may have occurred as there is no audible record on the bridge voice recorder.*

4.5.18 Baltic Ace was, by this time on a heading of 012°, the two vessels were almost on opposing courses. At the time Corvus J applied 15° of starboard rudder which induced a rate of turn of about 55° per minute. The Baltic Ace was in the turn to port at a rate of turn of approximately 16° per minute.

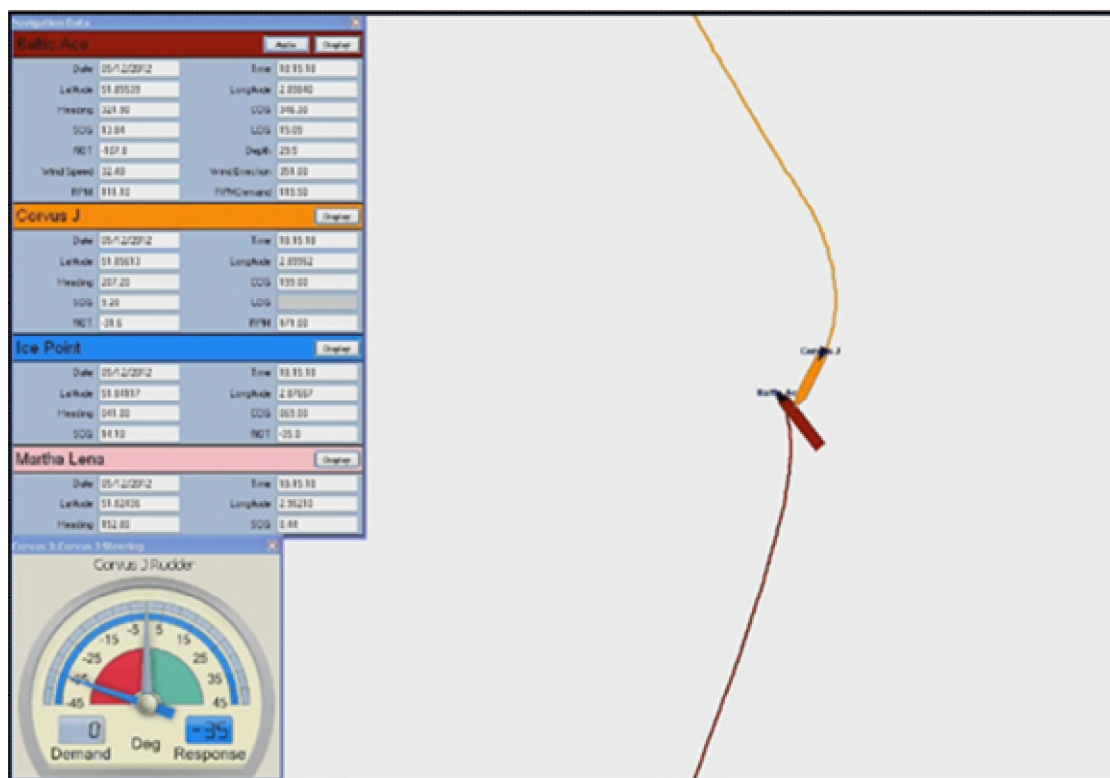

Figure 19: Point of collision: Baltic Ace heading 321°, Corvus J heading 207°

4.5.19 Analysing the more detailed replay data using the relative headings and positions of the two vessels it is estimated that Corvus J would first have been able to see both sidelights of the Baltic Ace at approximately 18:14:40. By this time the two vessels were about 3 cables (600yds) apart as the Corvus J crossed ahead of the Baltic Ace on a heading of 182° and continued its alteration of course to starboard.

4.5.20 Confusion continued to escalate, the distance between the two vessels closed rapidly until the point at which a collision became imminent. In a final attempt to avert contact, the helm was eventually placed hard over to port. In the same instance however, the OOW on board the Corvus J was continuing with a previous alteration of course to starboard. Both vessels had significant momentum in the turn which resulted in the development of a t-bone situation where the Baltic Ace was presenting a starboard beam aspect to the bow of the Corvus J.

4.6 Damage Assessment

4.6.1 The BMA contracted London Offshore Consultants (LOC) to assist in the investigation to determine the cause of the capsize and subsequent sinking of the Baltic Ace. LOC used General Arrangement (GA) plans, photographic evidence of the Corvus J, VDR and audio evidence from both vessels, witness statements and a stability programme General Hydrostatic¹⁹ (GHS).

4.6.2 At the point of separation (see figure 19) at 18:15:46, the accelerated opposing rotation of the two vessels had resulted in the Corvus J dragging aft and extending the initial breach longitudinally down the starboard side (see figure 20).

¹⁹ GHS is a software system for the design and evaluation of all types of ships and floating structures. It addresses flotation, trim, stability and strength by calculating the forces involved using mathematical/geometrical models of the vessels.

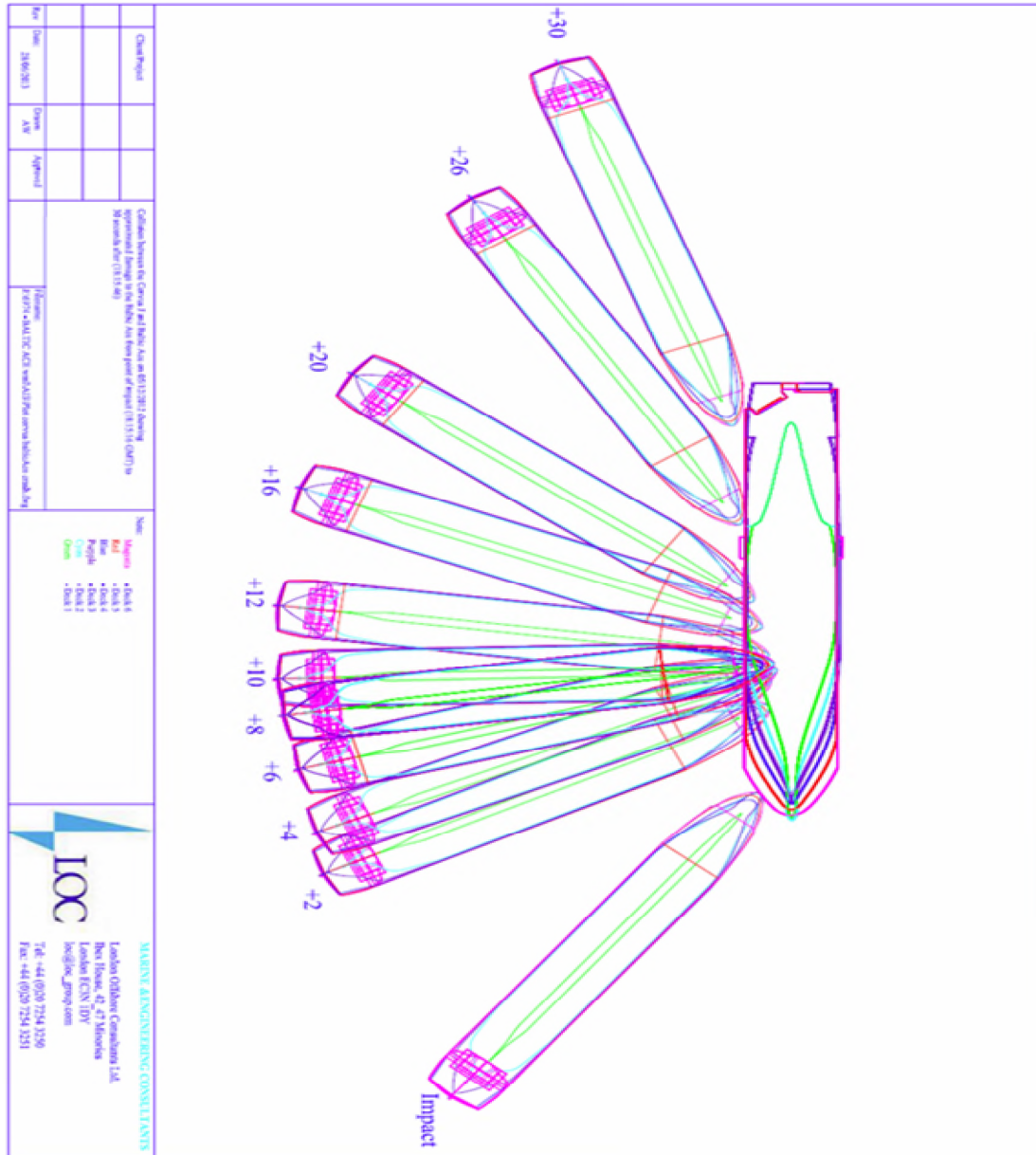

Figure 20: Damage assessment from impact (18:15:16) to 30 seconds after (18:15:46)²⁰

4.6.3 Immediately after the two vessels had separated from one another, an analysis of the VDR audio recordings on board the Baltic Ace indicate falling hardware and breaking glass, a sound that is synonymous with a large angle of inclination. Witness testimonies indicate that the vessel took on an immediate trim by the head after impact and began listing to starboard soon after. Analysis of the dimensions of both vessels supports this conclusion by providing an estimation of the position of penetration as seen in figure 20 above.

²⁰ The GHS model of the hull form was created based on the General Arrangement plan provided by the Owners. The hydrostatics of the model were validated against the values provided in trim and stability book using the tolerances from IACS (requirements concerning LOADLINE – IACS Req. 2004/Rev.2 2006).

- 4.6.4 Appendix II shows the damage sustained on the starboard side of the Baltic Ace was likely to be below the waterline, decks 02 and 03 and above the waterline on all decks up to and including deck 06.
- 4.6.5 The extent of damage sustained to the bow of the Corvus J (as seen in figures 21, 22 and 23) highlight the extent of the penetration to the side shell plating of the Baltic Ace. The perimeter of the Baltic Ace cargo hold is surrounded by ballast wing tanks and void spaces extending inwards from 1.3m and 2.6m respectively. Following visual analysis it can be determined that the surrounding spaces were fully penetrated resulting in immediate ingress of water to the cargo deck spaces.
- 4.6.6 Although the Corvus J sustained severe structural damage as a result of the collision, the watertight integrity of the vessel was not compromised. The vessel was therefore able to remain on scene to assist with the search and rescue operation.



Figure 21: Bow damage to Corvus J post collision



Figure 22: Port bow view of Corvus J post collision



Figure 23: Bow damage to Corvus J post collision

- 4.6.7 During the analysis, draught, heel and trim were measured against time from the point of impact. The results are provided within figures 24, 25 and 26 respectively.
- 4.6.8 Based on the damage plots it is clear that the vessel suffered a large tear on its starboard side opening up decks 2 to 7 almost instantly. The stability shows that the ingress of water caused a rapid increase in draught from 7m to

approximately 20m, 3 minutes after impact. The draught of the vessel then remained stable with a slow increase until 13 minutes after impact, at which point draught increased rapidly. All three data plots (figures 24, 25 and 26) remain consistent and demonstrate the severity of the damage by the speed with which the vessel lost all buoyancy.

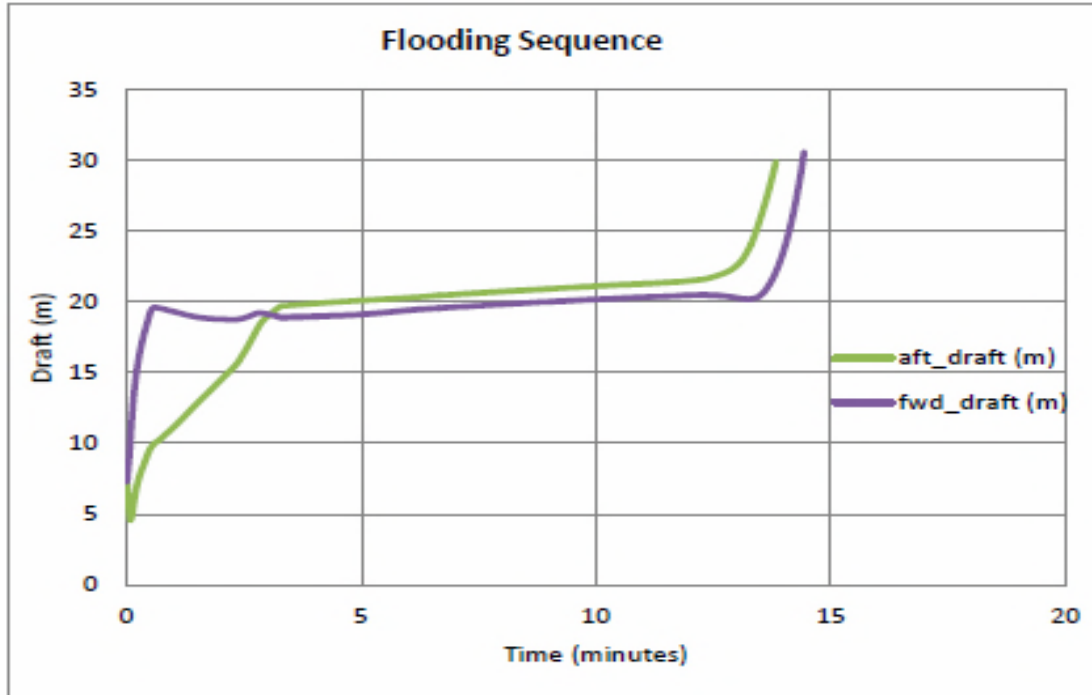

Figure 24: Analysis of Draught plot over time from the moment of impact commencing at 18:15:16 (0+) using GHS

- 4.6.9 The results provided below show that the vessel quickly took on a 50° list which reduced to 25° and then stabilised. The list then reduced to approximately 8°, 3 minutes after impact. The list then slowly increased until it reached 20° approximately 13 minutes after impact. After that the list rapidly increases until it reached 80°, 15 minutes after impact the vessel sinks below the water and comes to rest on the seabed on its starboard side.

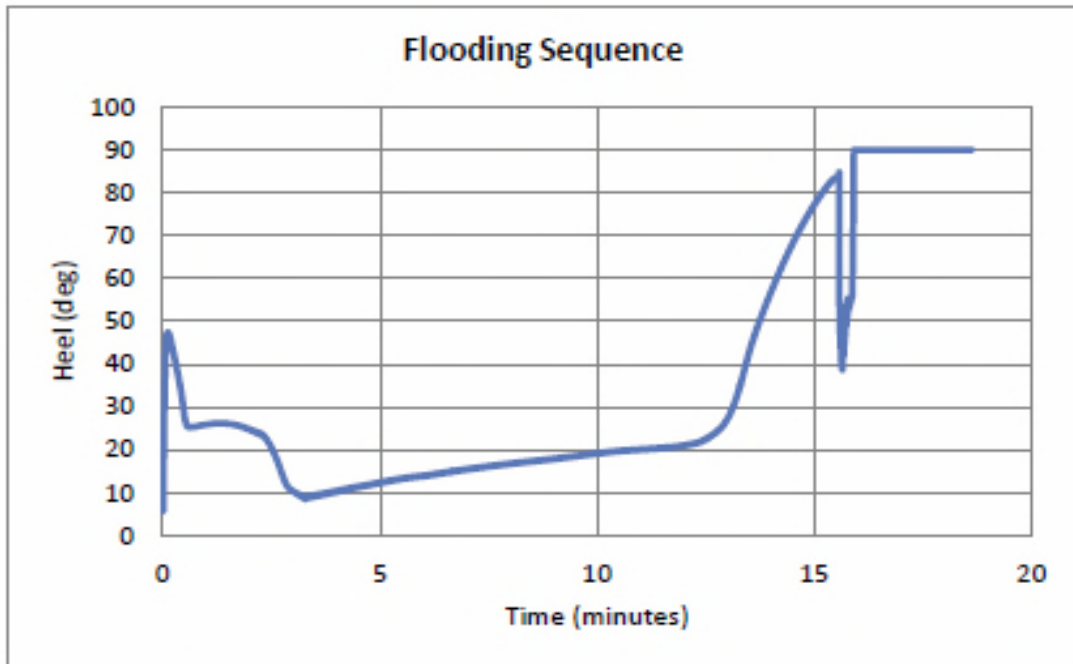

Figure 25: Analysis of Heel plot over time from the moment of impact commencing at 18:15:16 (0+) using GHS

4.6.10 The poor weather conditions that prevailed on the evening of the 05th December coupled with the extent of the damage that was sustained during the collision, the ingress of water into the cargo deck spaces would have occurred rapidly, to such an extent that the Baltic Ace capsized in approximately 15 minutes. The free surface effect²¹ would cause significant dynamic forces to act against the righting moment, and a detrimental effect to the vessel's residual stability reducing and potentially eliminating the positive GM that existed prior to the collision.

²¹ Free Surface Effect - Loss of GM due to the unobstructed atharwship movement of water

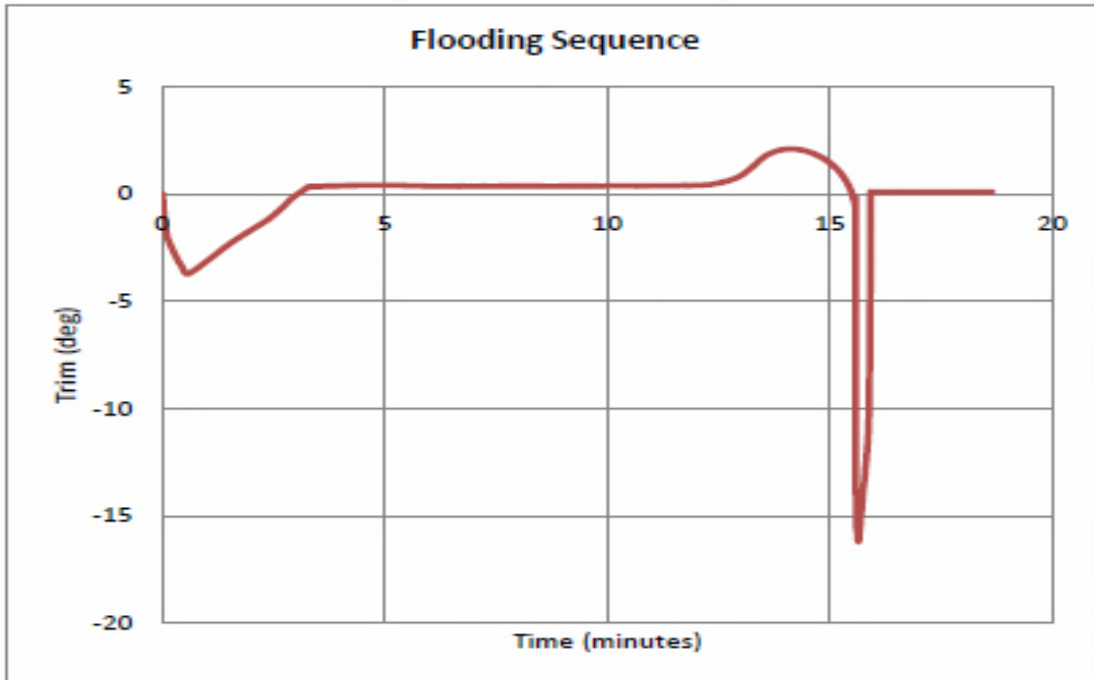

Figure 26: Analysis of Trim plot over time from the moment of impact commencing at 18:15:16 (0+) using GHS

4.6.11 The structural arrangement of the vessel consists primarily of two subdivisions within the internal structure. A transverse subdivision exists between the engine room (forward engine room bulkhead) and that of decks 1 through 4. This is the singular transverse subdivision separating two significant compartments within the structural arrangement. A subdivision exists longitudinally along deck 4 which is the load line deck that separates the lower hold from the upper hold and has no transverse subdivision. Figure 27 shows the transverse and longitudinal subdivision represented in red. Although the vessel has a low extent of subdivision, it did comply fully to Regulation 4 of Chapter II of SOLAS in regard to subdivision and stability.

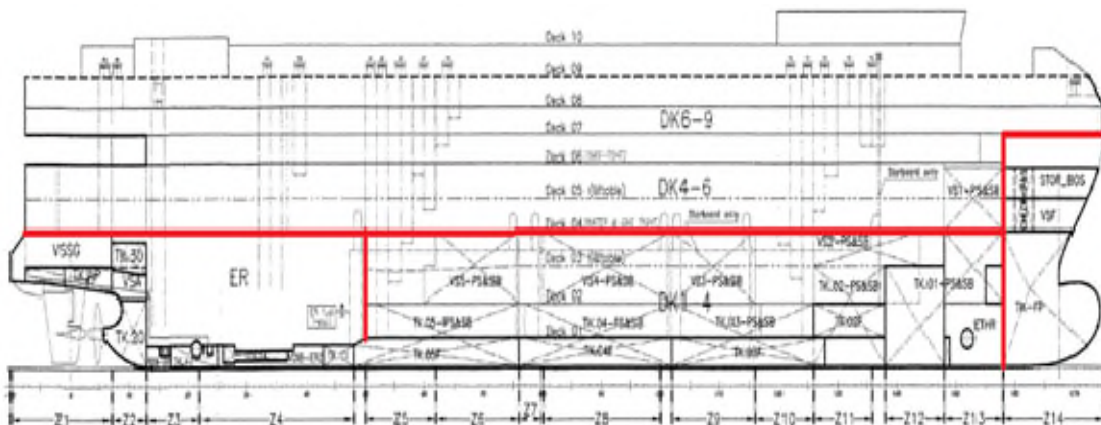

Figure 27: Damage Control Plan indicating watertight structural subdivision (in red)

- 4.6.12 Although the vessel complies fully with SOLAS, the reliance placed on the watertight subdivision being maintained is critical to the vessel’s reserve buoyancy and watertight integrity due to the presence of only one horizontal and transverse subdivision. The damage stability booklet indicates that the vessel should survive the complete flooding of the lower hold or flooding of the lower hold and the engine room providing deck 4 and above the watertight subdivision is not breached. In the event that the watertight subdivision becomes compromised a significant reduction in the amount of reserve buoyancy will be exhibited. When this occurs the watertight subdivision becomes partly or fully submerged below the final damage waterline.
- 4.6.13 The damage stability book for the vessel, approved by DNV on 13th September 2007 identifies, in the event of a structural breach the effect on the stability of the vessel. Within the damage control plan a statement is made highlighting the importance of the only longitudinal subdivision *“attention: the extremely dangerous situation occurs when deck 4 is damaged in most cases the ship will capsize or sink”*. Therefore any breach in the side shell above deck 4 could prove catastrophic if water ingress cannot be removed from the vessel at a greater or equal rate to which it is entering. In the event water ingress cannot be controlled there is no method of containing the water which now has access to the remaining cargo decks.
- 4.6.14 It has been determined from the evidence provided via GHS analysis, the vessel capsized due to the significant and rapid ingress of water between deck 2 and deck 6. Given the depth of penetration based on photographic evidence of the bow of the Corvus J it is unlikely that the loss of stability causing the initial heel could have been avoided given the compromised watertight integrity of the vessel above and below the longitudinal watertight subdivision between frame 135 and frame 50.

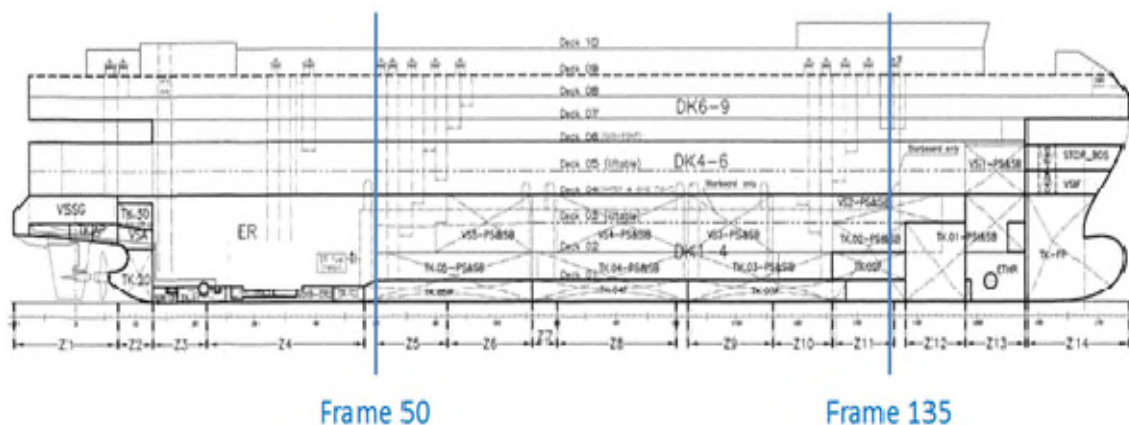

Figure 28: Frame location on Damage Control Plan

4.7 Abandonment

- 4.7.1 The crew of the Baltic Ace demonstrated immense bravery and courage, responding accordingly to the gravity of the situation and assisting one another where the opportunity required, displaying a degree of resourcefulness in order to manufacture a means of escape to safety.
- 4.7.2 The severity of damage sustained by the vessel became almost immediately apparent; the Master of the Baltic Ace sounded the emergency alarm almost immediately after impact to ensure the rapid evacuation of the crew from the vessel. Coastguard authorities were notified about the developing situation 5 minutes after impact by an emergency DSC broadcast.
- 4.7.3 The collision occurred at a time when the majority of the crew were either in their cabins or in the communal areas of the vessel located on deck 9. Within a matter of minutes the list adopted, significantly hindered the crews ability to gain access to deck 10, the location of immersion suit storage locker, muster stations and lifeboat embarkation platforms for both port and starboard lifeboats.
- 4.7.4 The speed at which the vessel's condition deteriorated allowed insufficient time to fully prepare for abandonment. Although many crew members remained together in small groups, in light of the circumstances any assigned muster duties and actions were inevitably replaced with ensuring individual survival.
- 4.7.5 The increasing angle of inclination resulting from the continued ingress of water prevented the launch of the vessels two lifeboats until such time as the vessel had capsized. As a result, only one crew member was able to successfully abandon the Baltic Ace inside the port lifeboat located on the 'high side' of the vessel. It is understood from the witness statements that the majority of those crew members who had the opportunity to abandon via the port lifeboat decided against that option in the event that the inherent buoyancy would not be sufficient to enable the lifeboat to float free from the chocks and clear of the vessel.
- 4.7.6 The majority of those who successfully abandoned the vessel found themselves immersed in water prior to boarding a life raft, which given the restricted access to immersion suits posed a greater risk of injury through exposure as well as the potential to be lost without reaching the intended raft.
- 4.7.7 Only two crew were wearing immersion suits upon recovery, it was determined later that both crew members had gathered their immersion suits in the early stages of abandonment as they were in the region of the immersion suit storage locker having come from the bridge. The majority of the crew however were unable to climb up to deck 10 from deck 9 due to the angle of list that was adopted so quickly and therefore did not have access to immersion suits prior to abandoning the vessel. The effectiveness of an

immersion suit is dependent on crew members not only being able to reach the suits but also having time to don them correctly.

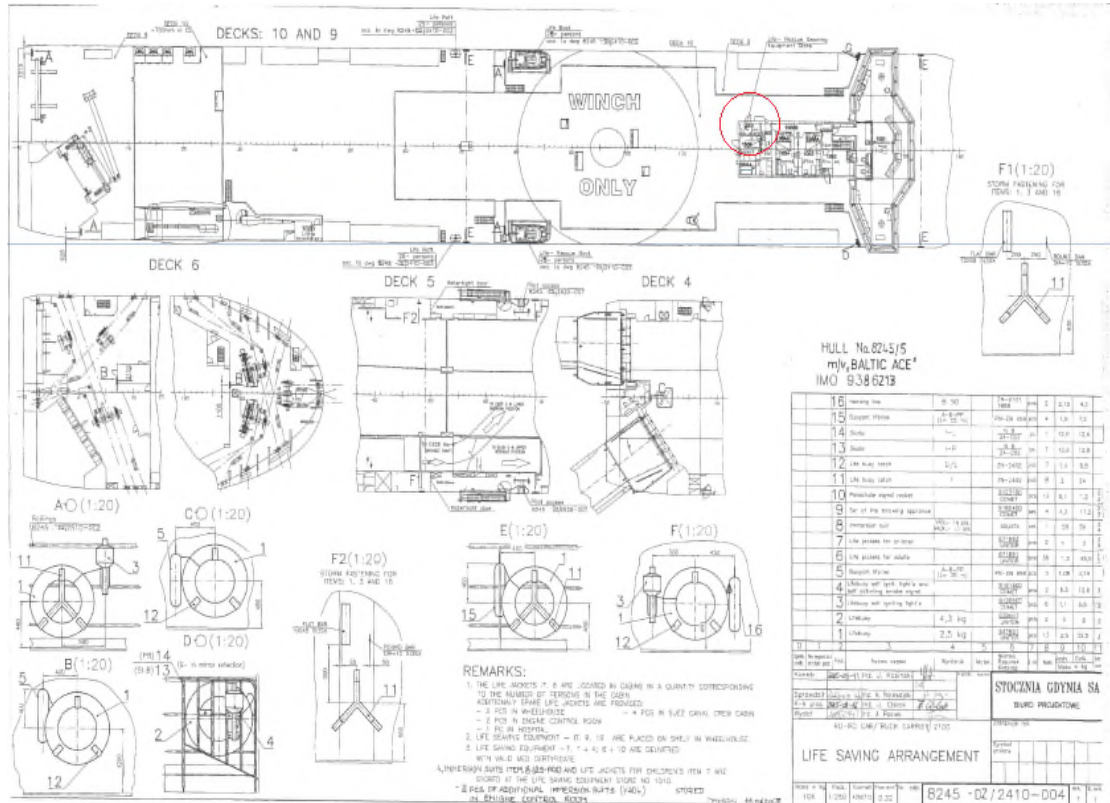

Figure 29: Baltic Ace lifesaving arrangement plan – Immersion suits stored within Life Saving Equipment Store on Deck 10 (circled)

4.7.8 A further 11 crew members were not rescued, 8 confirmed deceased and 3 remain missing, presumed deceased. This loss of life is reflective of the consequences and severity of a rapidly developing emergency situation in particularly extreme environmental conditions.

4.7.9 As well as the effects of hypothermia, survivors also suffered practical immobility due to exposure to the cold. This impaired their ability to use the equipment associated with the lifesaving craft, in particular pyrotechnics.

4.7.10 Both lifeboats were encountered by the Corvus J during the aftermath of the collision, starboard No.1 was found empty while No.2 port had one AB on board. The boats were subsequently recovered and their condition assessed. No.1 boat was damaged in way of the after hook which had released from the wire fall. The forward hook however was closed with the fall block attached to the fall wire, which had parted. The evidence suggests in all likely circumstances that the boat broke loose from the vessel due to its inherent buoyancy. No.2 lifeboat was in a good condition with no structural damage.

4.8 Search and Rescue Effort

- 4.8.1 In challenging and unfavourable conditions, the survival of 13 crew members depended on the participation of those vessels in the vicinity whose crew demonstrated excellent professionalism and seamanship proficiency to ensure their safe recovery.
- 4.8.2 The Master of the Baltic Ace, realising that the damage sustained was so severe abandonment was inevitable, raised the alarm by means of a distress call utilizing VHF. During that call he read the GPS position as follows “ $50^{\circ} 51'N 002^{\circ} 53'E$ ”. Given the speed with which the Baltic Ace sank, this vital piece of information was likely to have proved instrumental in saving time, particularly as vessels assisting the search and rescue effort made their way to the reported GPS position.
- 4.8.3 The Master and crew on board the Corvus J were at first preoccupied with ensuring the integrity of their own vessel. As soon as it became apparent that there was no ingress of water however, contact was established with the responding Rescue Coordination Centre (RCC) to provide rescue assistance to the Baltic Ace. Statements provided indicate that radio contact and lighting on board the Baltic Ace failed soon after the collision had occurred. Despite the activation of emergency lighting on the vessel thereafter, rescue operations were severely hampered as a result.
- 4.8.4 The RCC and HNLMS Friesland supported by a number of other vessels and helicopter support from both Netherlands and Belgium coastguards conducted the rescue operation of the surviving crew members from the Baltic Ace. It was considered during the investigation that those involved demonstrated courage and bravery in the face of an extreme situation, the result of which ensured the safe return of 13 crew members.
- 4.8.5 In total eleven (11) crew members were recovered from life rafts by helicopter operated by the Belgian and Dutch coastguards while a further two crew were recovered by vessels assisting the search and rescue effort.

5 CONCLUSIONS

5.1 Risk of Collision

- 5.1.1 The manning arrangements on board the Baltic Ace were sufficient for the intended operation of the vessel and the navigational situation prior to the collision. The provision of additional Officers to alleviate the short turnaround pressures associated with the vessel's trade pattern ensured that both the Master and Chief Officer were available to provide support to the Bridge team as and when required. The practice of extra manning above minimum levels is commended by the Bahamas Maritime Authority and is reflective of the operator's commitment to ensuring safety as a priority.
- 5.1.2 The composition of the bridge watch on the Baltic Ace ensured that the OOW was supported by a dedicated lookout who was in this case a deck cadet. Conversely, the OOW on board the Corvus J did not request assistance from another bridge watch-keeper to assist with the increase in bridge related activities and heightened workload as a consequence of the developing situation.
- 5.1.3 The manning arrangements on board the Corvus J were typical of smaller vessels operating on coastal trades. Although fully compliant with regards to the minimum manning requirements of the flag State administration, the Master was himself, maintaining a bridge watch to ensure that the statutory minimum hours of rest were fulfilled. This arrangement, albeit permitted under the operator's Safety Management System, is considered restrictive in terms of the Master's capability and capacity to provide support to his watch-keeping Officer's at critical stages of the passage.
- 5.1.4 Under Rule 5 of the COLREGS, *'every vessel is required to maintain a proper lookout by all available means so as to ensure a full appraisal of the situation and risk of collision'*. During the course of the investigation however, it became apparent that both watch-keeping Officers were relying solely on the data produced by ARPA to evaluate the developing situation. Despite the fact that a risk of collision had been identified at an early stage, by not monitoring the approaching vessel using visual bearings a full appraisal could not necessarily be obtained. This resulted in a delay in recognising the anomalies that were developing between the manoeuvres that had been agreed by VHF and those that were actually taking place.
- 5.1.5 By not appointing a dedicated lookout on the bridge of the Corvus J it is doubtful whether or not in this case, the OOW was maintaining a proper lookout by all available means. Reference is further made to STCW VIII/3-1 Reg. 14, the content of which states:

‘The look-out must be able to give full attention to the keeping of a proper look-out and no other duties shall be undertaken or assigned which could interfere with that task’.

- 5.1.6 Upon alignment onto a South Easterly course that would cross the North Hinder Junction precautionary area, the OOW on board the Corvus J detected a developing situation with two vessels approaching on the starboard bow, namely the Ice Point and Baltic Ace. Thereafter, having determined that risk of collision did exist and under the direction of Rule 15 of the COLREGS, the OOW should have taken *‘early action to avoid crossing ahead of the approaching vessels’*. The conscious decision to delay taking avoiding action in ample time and in accordance with the observance of good seamanship resulted in the establishment of VHF communication between the two vessels.
- 5.1.7 Both Officers proceeded to agree on a passing arrangement that would not only contravene COLREGS but was also extremely ambiguous in form. This confused the situation further by leading both Officers into a false sense of security that the situation had been adequately resolved, subsequently their action was not checked as required by COLREGS which would have highlighted in fact, that a risk of collision continued to exist.
- 5.1.8 The ambiguity of the VHF conversations between the two Officers that followed thereafter resulted in confusion about the actions that were being taken on either part. As a result, the OOW on board the Baltic Ace continued to alter course to port under the false impression that the resolution should continue as agreed. The OOW on board the Corvus J meanwhile, began altering to starboard, a decision that was likely reflective of his concerns about the developing situation.
- 5.1.9 With the Baltic Ace altering to port and the Corvus J altering to starboard and neither vessel taking any bold and definitive action that would be readily apparent to the other vessel observing visually or by radar, both Officers continued to underestimate the severity of the developing situation until both vessels were so close that a collision could not be avoided. The VHF agreed solution to the developing situation was in contravention of COLREGS. Had either vessel manoeuvred in accordance with COLREGS it can be considered that the probability of a risk of collision unlikely to occur.
- 5.1.10 The dangers associated with the use of VHF for purposes of collision avoidance are widely publicised²² within the shipping industry, particularly in relation to creating unnecessary confusion where a practical solution already exists. A more prudent course of action at this stage therefore, would have been to comply with the provisions of Rule 17(ii), the content of which affords the stand on vessel the ability to *‘take avoiding action by her manoeuvre alone, as soon as it becomes apparent that the vessel required to keep out of the way is not taking appropriate action’*.

²² Examples of which can be found via a Marine Guidance Note 324 para 7-13 courtesy of the MCA

5.1.11 In the event that the OOW on board the Baltic Ace considered this VHF-agreed manoeuvre complied with this rule, Rule 17(c) provides further clarification that when a crossing situation exists and where the circumstances of the case admit, *“the stand on vessel should not alter course to port for a vessel on her own port side”*. The OOW on board the Baltic Ace however may have deemed that an alteration of course to port may have improved the crossing distance between the two vessels. The assumption that both vessels are clearly aware that a departure from the rule is being followed can only be achieved by unambiguous communication. As proven by events, unambiguous understanding is extremely difficult to achieve beyond doubt with VHF communications.

5.2 Safe Speed

5.2.1 As the two vessels drew closer to one another, there was no reduction of speed evident on either part despite the uncertainties that were developing. Under Rule 6, *‘every vessel is directed to proceed at a speed where she can take proper and effective action to avoid collision’*. Given that a collision did occur between the two vessels, it cannot be considered that either was proceeding at a safe speed.

5.3 Sinking of the Baltic Ace

5.3.1 The speed of both vessels as they collided with one another coupled with the opposing rotation of opposite helm orders resulted in a hull plating breach that penetrated into the cargo deck spaces forward of amidships and continuing aft to frame 50. This breach coupled with the prevailing weather conditions at the time of the collision resulted in a fast and substantial ingress of water into the vessel’s cargo space.

5.3.2 The breach of the shell plating from frame 135 to frame 50 and vertically from deck 2 to deck 6 proved catastrophic resulting in the vessel’s rapid capsize. The vessel’s structural arrangement provides for a component of reserve buoyancy above the waterline subdivision, sufficient enough to maintain the vessel’s buoyancy should the lower cargo holds become submerged. The damage sustained due to the impact resulted in the watertight integrity above the watertight subdivision to become compromised, thereby removing the designed reserve buoyancy necessary to keep the vessel afloat. With no transverse subdivision above the watertight subdivision of deck 4, unrestricted flooding occurred throughout the remaining cargo decks. The Baltic Ace could not recover from the damage sustained, the extent of which allowed little time for the crew to evacuate in a controlled and organized manner.

5.4 Evacuation

- 5.4.1 The decision by the Master of the Baltic Ace to sound the abandon ship emergency alarm immediately after the collision was realistically the only course of action that could have been taken. Whether or not a full assessment of the damage had been completed at this stage is immaterial – the vessel was sinking rapidly.
- 5.4.2 The fact that the angle of inclination was increasing rapidly meant that there was insufficient time for crew members to reach the immersion suit storage locker on Deck 10 before surfaces became too steep to manage. This resulted in only 2 crew members being able to don immersion suits prior to abandoning, both of whom were stationed on the Bridge on Deck 10. Had storage lockers been placed in multiple locations on the upper decks, allowing access to crew who could not reach the muster station but instead gain access to the upper decks, it is considered far more likely that crew members may have been able to don immersion suits in time.
- 5.4.3 The angle of inclination prevented either lifeboat from being launched until such time as the vessel had almost capsized and the launch and recovery equipment had given way permitting the craft to float free. This restricted the abandonment operation to the life rafts only. Given that these could not be launched on board to enable a dry shod evacuation, crew members had to enter the water in order to abandon ship.
- 5.4.4 Those helicopter units and vessels that went to the aid of the stricken vessel the Baltic Ace on the evening of the 5th December deserve significant praise for their exceptional bravery, skill and good seamanship demonstrated in particularly challenging conditions.

6 RECOMMENDATIONS

Recommendations for the operator:

- 6.1 Masters and watch-keeping Officers should be apprised of the findings of this investigation and alerted to the navigational occurrences that have been identified within this report, in particular those associated with the use of VHF for the purpose of collision avoidance.

Action Taken:

The Company has met this recommendation in full.

- 6.2 Consider implementing a procedure to conduct annual navigational audits in order to verify the function of safety of navigation and ensure effective implementation of navigational procedures.

Action Taken:

The Company, in preference to a Navigational Audit, implemented a training programme utilising Compulsory Basic Training (CBT) assessment modules, presentations and analysis methods focusing on COLREGs, delivered to all bridge watchkeepers within their fleet and verified during periodic ISM internal audits.

- 6.3 A review of the location of survival equipment should be conducted to ensure that it is stowed in multiple locations where it is least likely to be damaged yet most likely to be reached.

Action Taken:

The Company has conducted a review and determined that locating all immersion suits in one place is the best strategy for responding to the majority of emergency situations.

- 6.4 Consider a review of the internal examination and assessment process in the knowledge of COLREGS for all Officers of the Watch, in particular their ability to demonstrate a thorough knowledge of the content, application and intent of COLREGS.

Action Taken:

The Company has met this recommendation in full.

LIST OF APPENDICES

- I. Baltic Ace general arrangement plan
- II. Baltic Ace damage plots
- III. Pictures of Baltic Ace after salvage recovery

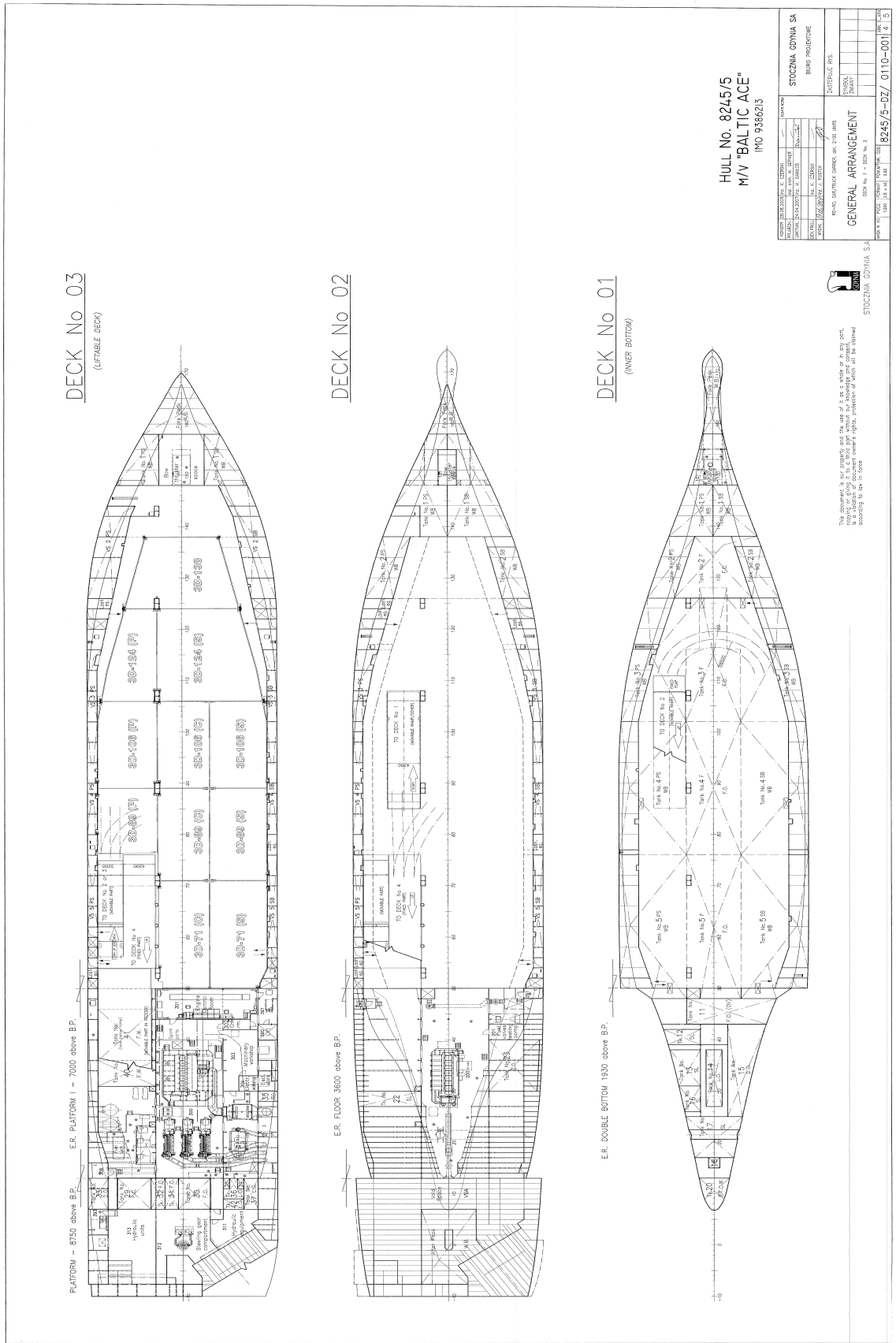

Figure 31: Baltic Ace General Arrangement Plan (decks 1, 2 & 3)

m.v Baltic Ace – Marine Safety Investigation Report

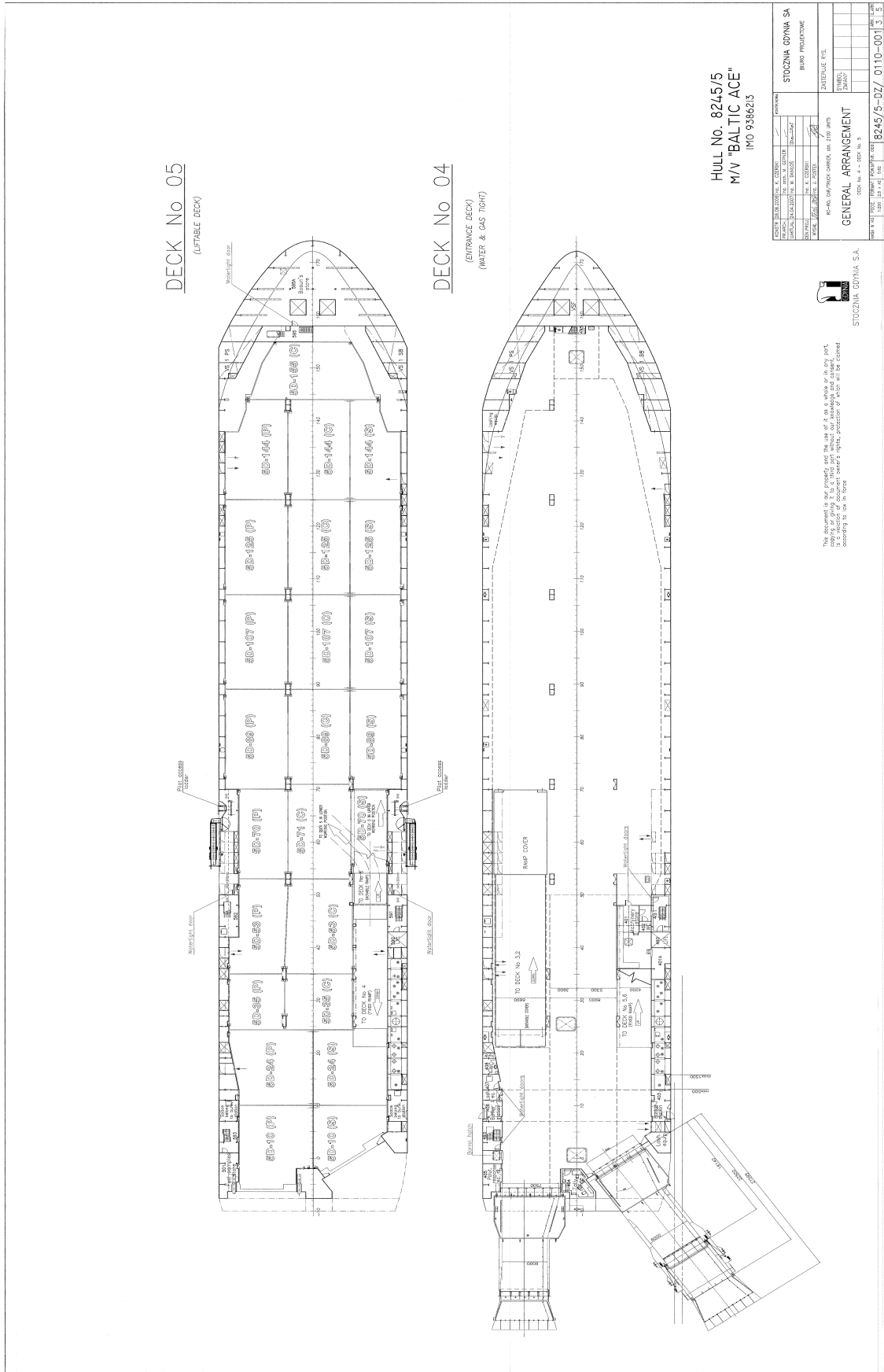

Figure 32: Baltic Ace General Arrangement Plan (decks 4 & 5)

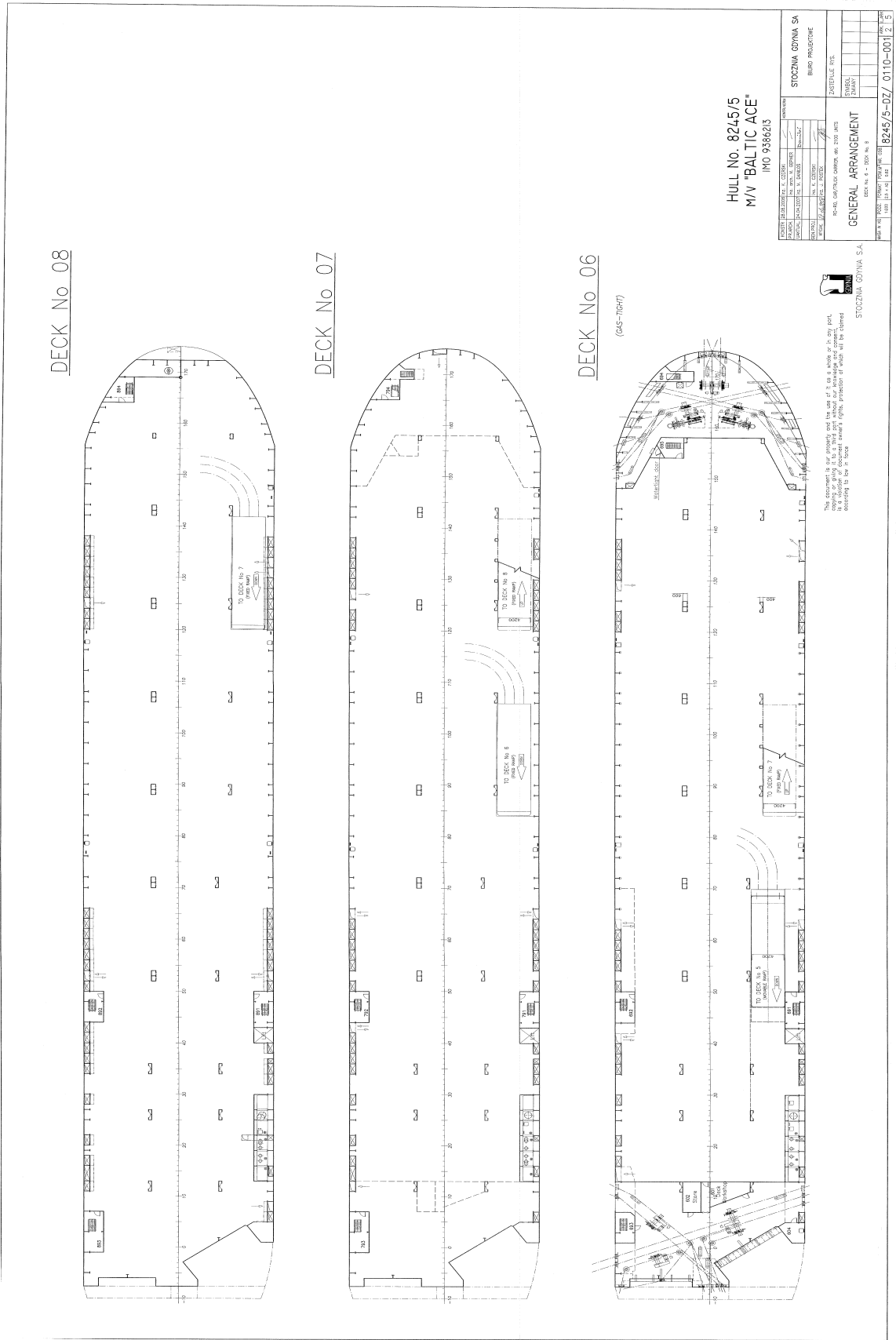

Figure 33: Baltic Ace General Arrangement Plan (decks 6, 7 & 8)

Appendix II: Baltic Ace Damage Plot

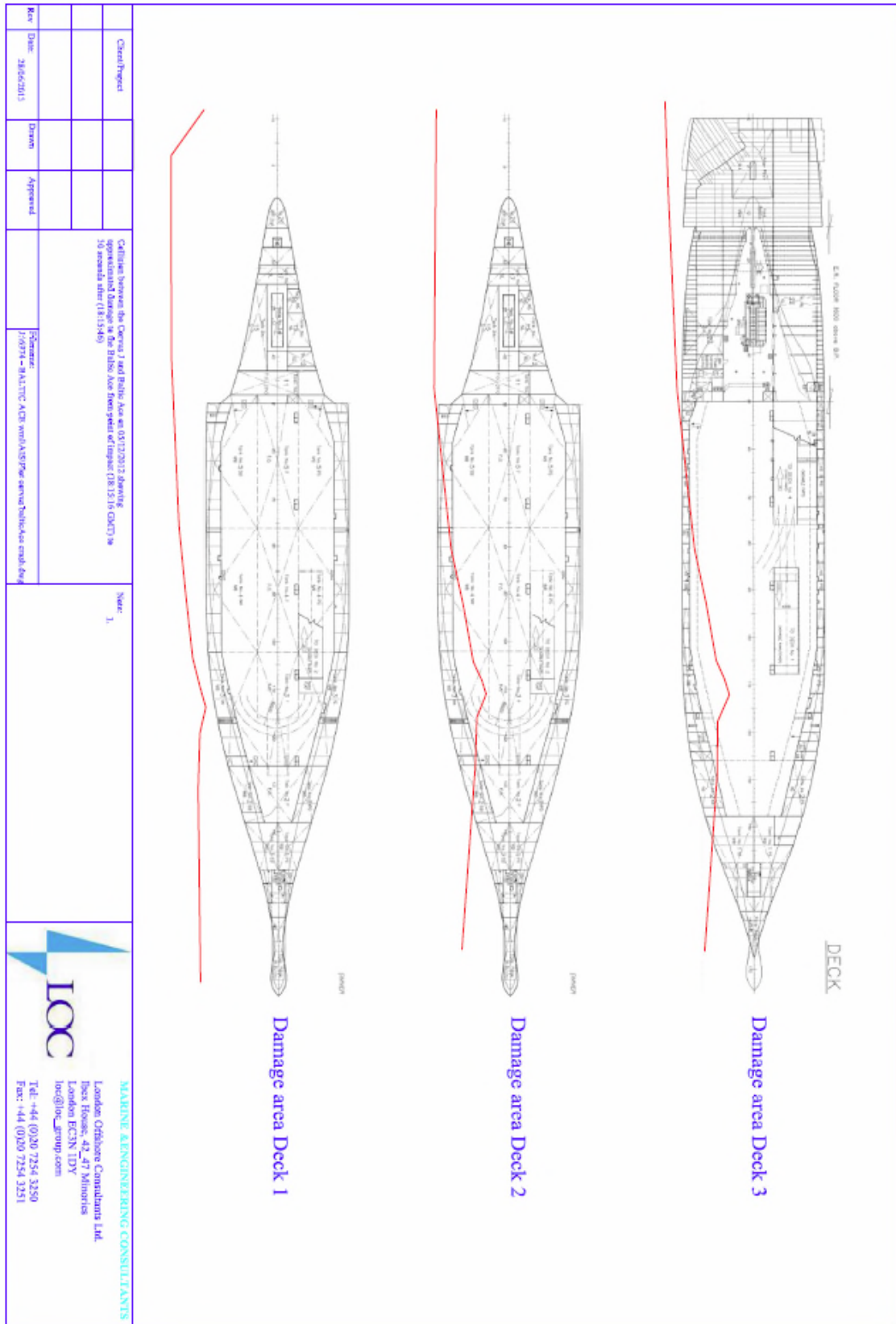

Figure 34: Baltic Ace Damage Plot (decks 1, 2 & 3)

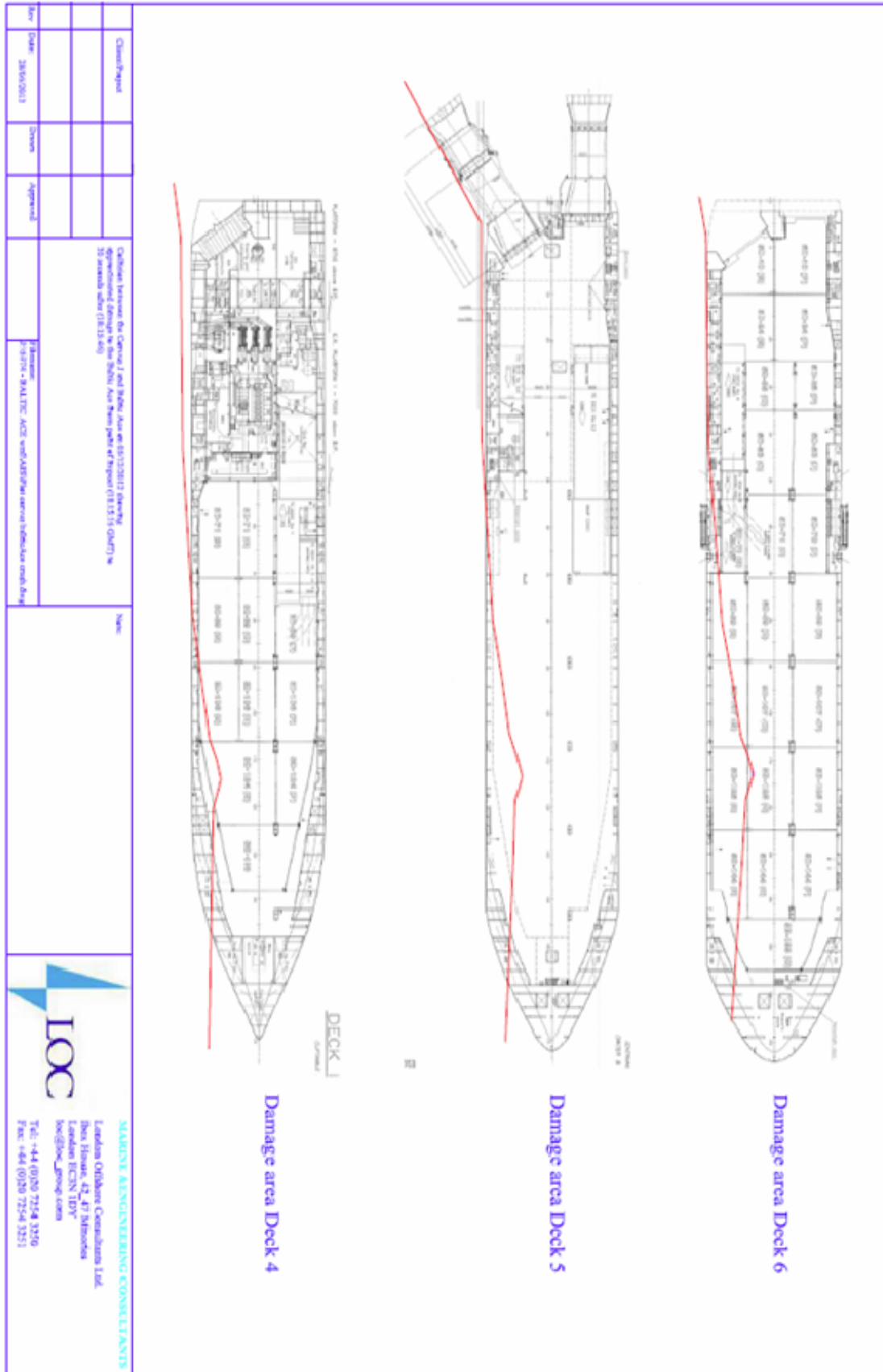

Figure 35: Baltic Ace Damage Plot (decks 4, 5 & 6)

Appendix III: Salvage Pictures - Rotterdam during the recovery process by salvors (July 2015)



Figure 36: Bow section



Figure 37: Bow section



Figure 38: Middle section (cargo decks)



Figure 39: Middle section (cargo decks)